

# Wireless World

RADIO AND ELECTRONICS

## RADIOLYMPIA



OCT. 1949

2/-

Vol. LV. No. 10

IN THIS  
ISSUE:

RADIOLYMPIA SHOW GUIDE



Made from solid-drawn high-conductivity copper, BICC earthing rods are specially designed for use with radio and television receivers. Further information, including sizes and construction, is contained in this Publication (No. 243 T). Send for a copy to-day.

**BRITISH INSULATED CALLENDER'S CABLES LIMITED  
NORFOLK HOUSE, NORFOLK STREET, LONDON, W.C.2**

# Wireless World

RADIO AND ELECTRONICS

OCTOBER

1949

39th YEAR OF PUBLICATION

Proprietors : ILIFFE & SONS LTD.  
 Managing Editor : HUGH S. POCKOCK, M.I.E.E.  
 Editor : H. F. SMITH

Editorial Advertising and Publishing Offices :  
 DORSET HOUSE, STAMFORD STREET,  
 LONDON, S.E.1.

Telephone : Waterloos 3333 (60 lines).  
 Telegrams : "Ethaworld, Sedist, London."

PUBLISHED MONTHLY

Price : 2/-

(Publication day : last Thursday of preceding month)

Subscription Rate : 26/- per annum. Home and Abroad

Branch Offices :

Birmingham : King Edward House, New Street, 2.  
 Coventry : 8-10, Corporation Street.  
 Glasgow : 26B, Renfield Street, C.2.  
 Manchester : 260, Deansgate, 3.

## In This Issue

EDITORIAL COMMENT .. .. .	361
MAGNETIC RECORDING TECHNIQUE By D. Roe .. .. .	362
HIGH-QUALITY AMPLIFIER : NEW VERSION By D. T. N. Williamson .. .. .	365
MICROWAVE LENSES By C. Susskind .. .. .	370
AIR RADIO .. .. .	373
MAINS-BATTERY TURNTABLE By I. C. Hutcheon .. .. .	375
NATIONAL RADIO EXHIBITION, 1949 .. .. .	376
WORLD OF WIRELESS .. .. .	385
SMOOTHING CIRCUITS—I By "Cathode Ray" .. .. .	389
MANUFACTURERS' PRODUCTS .. .. .	393
UNBIASED By "Free Grid" .. .. .	394
ELECTRONIC CIRCUITRY By J. McG. Sowerby .. .. .	395
SHORT-WAVE CONDITIONS By T. W. Bennington .. .. .	397
VENTED LOUDSPEAKER CABINETS By C. T. Chapman .. .. .	398
HIGH-VOLTAGE MEASUREMENT .. .. .	400
REFLEX VALVE VOLTMETER By M. G. Scroggie .. .. .	401
THERMISTORS .. .. .	405
LETTERS TO THE EDITOR .. .. .	408
RANDOM RADIATIONS By "Diallist" .. .. .	410
RECENT INVENTIONS .. .. .	412

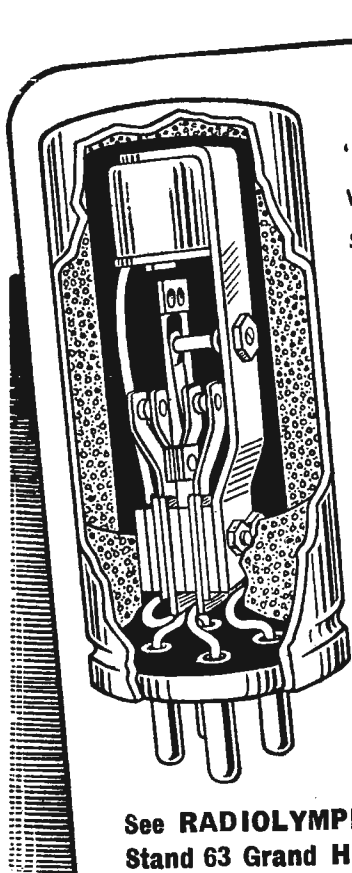

"Stratosil" fully sealed vibrators are supplied in synchronous, non-synchronous and split-reed synchronous types. Being available in both shunt and series drive (the latter being made under "OAK" patents) they offer a replacement service for the majority of American-pattern vibrators as well as covering fully the needs of the designer of new equipments.

See RADIOLYMPIA Stand 63 Grand Hall

WEARITE

## VIBRATORS

*set the standard for efficiency*

A data book, complete with replacement guide and transformer design information is now ready and will be gladly sent to you at 6d. post free. Please use the coupon.

### POST THE COUPON NOW

Wright & Weaire, Ltd., 138 Sloane Street,  
 London, S.W.1, England  
 Please send me VIBRATOR DATA BOOK for which I enclose 6d.  
 Name and Address .....

W W 1049

# Wright and Weaire Limited

138, SLOANE ST. · LONDON · S.W.1 TEL SLOANE 2214/5 FACTORY: SOUTH SHIELDS, CO. DURHAM



# Valves and their applications

## TELEVISION SYNCHRONIZING & TIME BASE CIRCUIT USING EF42, ECC34 & EL38. No. 1.

Previous articles have, in general, been concerned with one valve or one circuit stage; it frequently happens that

more complex problems are encountered in combining a number of valves and stages to make a complete equipment and this article and the next three deal with television receiver synchronizing and time base circuits. A practical circuit with complete operating and constructional details is given as an illustration of the solution of this type of problem. The circuit, though employing only five valves for all the functions of synchronizing, scanning, and E.H.T. derivation, and being economical in components, will be found to give excellent stability of synchronization under conditions of interference and will also give good linearity.

A block schematic diagram in Fig. 1 gives the valve and stage arrangement. It will be seen that the functions of frame output amplifier and line blocking oscillator are carried

prohibitive size. A circuit and valve must, therefore, be provided which supply this magnetizing current of parabolic form and the load current of linear form.

If the output valve has a high output impedance (e.g. a pentode) the grid potential waveform will be substantially the same shape as the anode current waveform. On the other hand, if the output valve has a low output impedance (e.g. a triode) the grid potential waveform will be substantially the same shape as the anode potential waveform, which is linear during the scan.

The potential waveform obtained from most time base oscillators has an exponential form such that the slope decreases during the scan while the waveform of the total valve current should increase in slope during the scan. It is evident that the correction needed to produce the correct grid potential waveform will be easier when a triode or low impedance valve is used. Conversely, when a given degree of correction is available a triode valve will allow a greater proportion of the current to be parabolic in form and a smaller transformer can

then be employed. Furthermore, one of the most convenient and effective methods of waveform correction uses potential negative feedback which reduces the effective output impedance of the valve in addition to conferring the other advantages of negative feedback. Negative feedback of approximately 5:1 should be used with all frame time bases to reduce the effects of microphony in the output valve which otherwise would need to be more rigidly constructed and its cost would be greater. From the point of view of microphony a low  $\mu$  triode is also better

than a high slope pentode as a blocking oscillator. Hence, if no limitation such as a low value H.T. line is imposed, the triodes of the ECC34 have great advantages for frame time base circuits, and the use of double-triodes has enabled the economical arrangement of Fig. 1 to be employed.

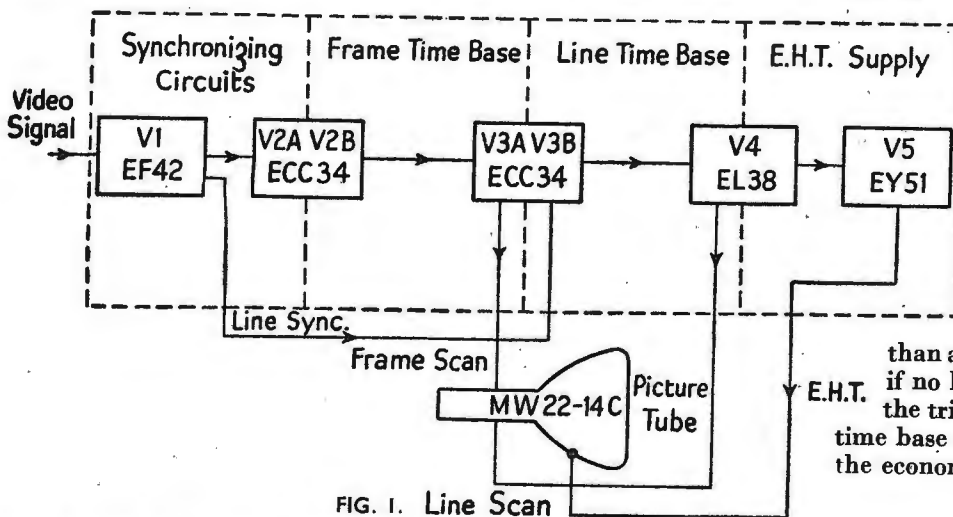

FIG. 1. Line Scan

out in one valve envelope. This avoids the risk of non-interlace which would attend the combination of the line blocking oscillator with the frame blocking oscillator or frame synchronizing pulse separator. The triode used for frame synchronizing pulse separation gives an amplified pulse and a very steady hold as a result. Thus, this arrangement gives a better performance than one using a diode or double diode for separating the frame synchronizing pulse and a separate valve for the line time base oscillator, and is more economical in valves and components.

The frame output valve is transformer coupled to the deflector coils. As with all frame output transformers it is not possible to make the magnetizing current negligible compared with the load current without using a core and windings of



Reprints of this report from the Mullard Laboratories, together with full transformer and coil winding data can be obtained from the address below. The complete circuit will be given in the next issue of the "Wireless World".

**MULLARD ELECTRONIC PRODUCTS LTD.,  
TECHNICAL PUBLICATIONS DEPARTMENT,  
CENTURY HOUSE, SHAFTESBURY AVE., W.C.2  
(MVM 105)**

# Wireless World

VOL. LV. NO. 10

OCTOBER, 1949

RADIO AND ELECTRONICS

MONTHLY COMMENTARY:

## *Radiolympia, 1949*

**T**HE more obvious purpose of a radio exhibition is strictly commercial; it acts as a convenient shop window, and the commercial exhibitor hopes to recoup himself for a considerable expenditure—of time, effort and money—by an immediate increase in sales. Taking the long-term view, the aim should be to encourage the widest possible section of the public to take an intelligent and serious interest in all branches of radio. And to those already “in the game” an annual exhibition should be a kind of focal point of the year.

**I**N our view, pre-war exhibitions failed lamentably in all these respects. They were too specialized, and concentrated mainly on “selling” broadcasting—which was already sold—rather than on selling equipment, or, on the broader issue, showing the year’s progress in all branches of the industry. True, there were some signs of improvement in 1939; the fiasco of the exhibition of that year was in no way the fault of the organizers, but was due to the fact that it coincided with the outbreak of war. Broadly speaking, however, it was not until the first post-war exhibition of 1947, which came under the wing of the Radio Industry Council (itself a war-time creation) that the exhibition took on what we think to be the right shape. It proved a great success, and did much to re-establish in the eyes of the world the prestige of the British radio industry, and to offset much of the harm that had been done by ill-advised delays in permitting the publication of detailed technical information on war-time developments. Attendances at the 1947 exhibition reached record figures; true, some of that attendance comprised “exhibition addicts” and so was not of any great value, but we know from our own observation that there was a very high proportion of deeply interested and serious visitors, including

users and would-be users of every kind of radio and radio-like equipment.

Radiolympia, 1949, follows the essential pattern of its immediate predecessor of 1947. In spite of one or two regrettable defaults, the show which will have opened when this appears in print should be adequately representative of all branches of radio and its offshoots, and there is little to criticize in its general plan. Though it may be urged that television is given undue prominence, the organizers could hardly do otherwise at a time when our national service is in process, at long last, of being extended, and with further extensions in prospect.

So far as can be judged at present, there is a lack of the more serious kind of educational exhibit which, we suggest, would be a highly desirable feature. Developments in our field are still so rapid that there is small wonder that the layman, even of the best informed type, can hardly be expected to know what radio can (and cannot) do for him. To some small extent the exhibits of the various non-commercial bodies and Government departments fill this gap, but the kind of thing we have in mind would be of a rather more detailed nature, and might well be presented by the various industrial organizations.

**E**LSEWHERE in this issue we present information which, it is hoped, will serve as a convenient guide to the visitor to Olympia, and, at the same time, will be of some value to readers, including those overseas, who are unable to go to the show. In addition to a plan of the exhibition, with lists of exhibitors, we give in tabular and graphical form a quick-reference index to the stands on which the various classes and types of radio and electronic equipment are to be seen. This information is as complete as possible up to the time of going to press. In our next issue we hope to give a detailed review of the show.

# MAGNETIC RECORDING

THE general theory of magnetic recording has already been covered in this journal,\* and it is the purpose of the present article to cover the more practical aspects and to draw attention to some of the finer points of technique, now that tape

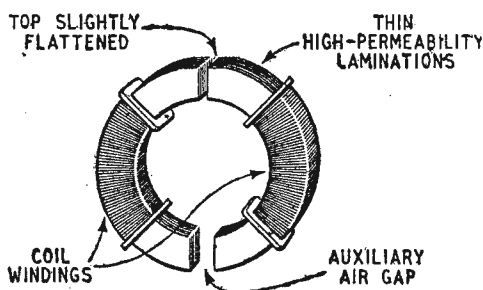

Fig. 1. Essential features of a magnetic recording head

and wire are available, e.g., from E.M.I. Factories, Ltd., Hayes, Middlesex, and Wirek (Electronics), Deansbrook Road, Edgware.

**Heads (General):** Modern magnetic heads are made in ring or toroidal form. Usually the rings are cut in half and each half fitted with a coil (Fig. 1). The halves are then clamped together with non-magnetic spacing shims to give two accurately dimensioned gaps. The magnetic recording medium is arranged to lie in contact with the outer face of the core for about  $\frac{1}{8}$ th of an inch on either side of one of the gaps. Different gap widths are used for the erase, record and playback heads, typical values being 20 mil, 1 mil and  $\frac{1}{2}$  mil respectively (1 mil = 0.001 in.).

Heads for use with tape are generally made from a stack of 5 mil ring laminations, the thin gauge being necessary to reduce eddy-current losses at high frequencies. Heads vary from  $\frac{1}{2}$  in to 1 in outside diameter, with about  $\frac{1}{8}$  in wall. High-permeability nickel-iron alloy, such as Mu-metal or Permally-C, is used, as it is essential to have the lowest possible reluctance at the pole-piece tips for a sharply defined

magnetic field. Laminations are clamped together and the gap edges ground straight and square. The tape contact area is also smoothed. Finally the laminations are annealed to restore maximum permeability and then cemented solidly together. A hard material, such as beryllium-copper, is used for the shims to prevent rounding of the gap edges.

Less efficient tape heads may be made by bending two  $\frac{1}{4}$  in wide strips of 15-mil material into semi-circular shape. The loss in efficiency occurs mainly at low frequencies owing to the low iron/copper ratio, so that these heads are more suitable for use at low tape speeds, where, as will be seen, the bass response is relatively greater. These heads work quite well un-annealed, but there is a comparative treble loss of about an octave.

A head for wire recording is very similar, but consists of a single-ring lamination, about 10 mil thick, clamped between non-magnetic side pieces. These side pieces are bevelled so as to form a

give better magnetic contact with the round surface. It is not necessary for a head to be of perfect ring form. Rectangular laminations may be used, with a curved edge or a felt pad to keep the medium in contact with the gap. But it is important to keep the head symmetrical and the coils identical; an astatic head picks up much less hum, which is a very real problem in magnetic recording.

Coils may be of high or low impedance according to circuit requirements. Low impedances have the advantage that self-supporting coils of thicker wire may be used. The playback head, however, must be of high impedance, or used with a step-up transformer, for maximum voltage output to be developed.

**Erase Head.**—A fairly wide gap is used in the erase head so that the erasing field spreads sufficiently for each point of the passing wire or tape to be subjected to a hundred or so gradually decreasing demagnetizing cycles. But the gap must not be too large or the maximum value of the field will

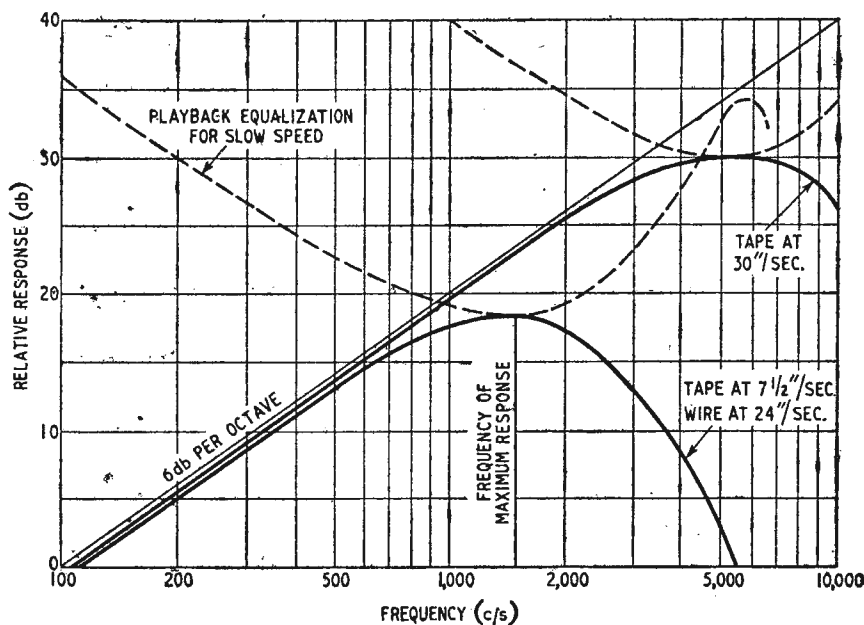

Fig. 2. Typical constant-current response curves with playback equalization for two different tape speeds.

V slot leading down to the edge of the lamination. The wire runs on the edge of the lamination and a shallow groove is usually provided to keep the wire central and to

not be enough to saturate the medium, and previous recordings will not be erased completely. To obtain sufficient erase current the inductance of the erase head is

\* "Magnetic Recording," G. L. Ashman, Aug. 1944, p. 226.

"The Gesman Magnetophon," R. A. Power, June 1946, p. 195.

# TECHNIQUE

## Practical Notes for the Experimenter

By **DESMOND ROE** (Birmingham Sound Reproducers)

often tuned to the frequency of the ultrasonic oscillator by means of a series condenser. It is quite common for an erase head to run warm. 100 ampere-turns is a typical energizing value. Radio-metal is better than Mumetal for erase heads.

**Recording Head.**—In recording with modern "ultrasonic bias," the actual flux density recorded depends on the instantaneous value of the magnetizing field at the moment the medium leaves the gap and passes into the relatively field-free region of the rear pole-piece. Hence the actual gap width is of less importance than the rapidity of the decay of the magnetic field at the rear gap edge. It is important, therefore, that the rear edge be sharp and square, and the material fully annealed for lowest reluctance if the maximum high-frequency response is to be recorded.

**Playback Head.**—For good treble response on playback, "scanning" loss must be a minimum, so the playback gap is made very narrow, about  $\frac{1}{4}$  to  $\frac{1}{2}$  mil. The gap should not be too narrow or else efficiency will be lowered due to the magnetic flux from the medium leaking back across the gap instead of going through the pick-up coils. Pole-pieces are slightly tapered to the point where they meet the medium, so that the actual amount of parallel gap is small. In the case of wire heads, it is usual to clamp the two pole-pieces, remove the spacer and soft solder the pole tips in position.

**Frequency Response.**—In any sound recording system, to obtain the maximum signal-to-noise ratio, there should be equal likelihood of overload at all frequencies. In magnetic recording the overload point is set by the saturation level of the magnetic medium. Saturation is independent of frequency, and depends only on the magnetizing field of

the recording head; that is, on the recording ampere-turns. Constant recording current, therefore, produces constant peak flux.

On playback the voltage induced in the playback head is proportional to the rate of change of flux, and as the flux reversal is clearly more rapid at higher frequencies, owing to the shorter wavelength, the playback output rises with frequency at a rate of 6 db per octave. However, at very high frequencies the minute magnets representing individual cycles become very short and of a size comparable with the thickness of the wire or tape. Consequently the well-known demagnetization of short mag-

netic overload. However, most of the equalization has to be applied during playback. Between 18 db and 30 db of bass boost at 100 c/s is required, according to the recording speed. Treble boost is usually obtained by means of a damped tuned circuit, which more closely complements the recording curve.

A typical playback equalizer circuit is shown in Fig. 3. Owing to the large amount of bass boost used on playback, great care has to be taken to shield the playback head from magnetic hum pick-up. One or more screening cans of high-permeability alloy may be needed, and the head should be spaced as far as possible from drive motors and mains transformers.

**Distortion.**—Superimposition of a steady high-frequency tone upon

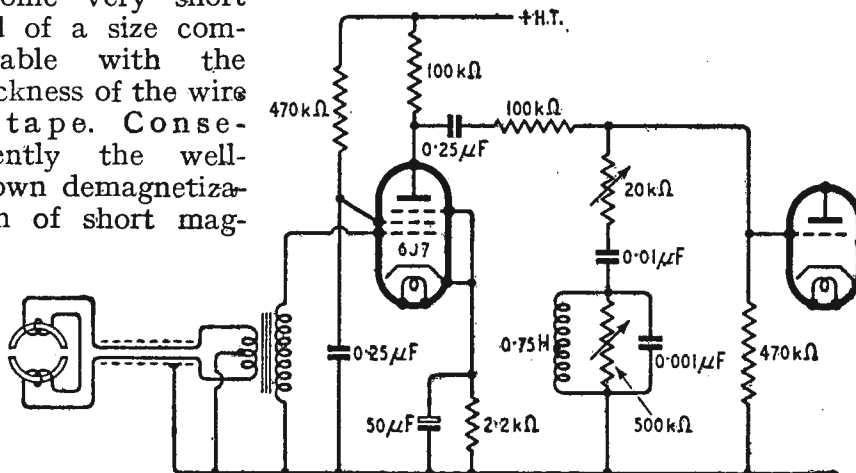

Fig. 3. Playback equalizer circuit for low-speed recording.

nets occurs, resulting in considerable high-frequency attenuation. A typical playback response curve of a constant current recording is shown in Fig. 2. It should be noted that this curve is more or less constant in shape for a given wire or tape, and with changes in recording speed merely shifts proportionately, parallel to the 6 db per octave line.

Constant current in the recording head is obtained by feeding it from a constant-voltage high-resistance source, or through a series resistance from a source of low resistance. Magnetic recording requires a power of only about 10 mW, so the resulting power transfer loss is not important. In recording, some treble boost and a little bass boost may be used without risk of frequency-

the audio signal while recording on a completely unmagnetized medium has been found to produce a linear magnetic recording characteristic of greater volume range than previous methods, together with much less background noise. The frequency of this "ultrasonic bias" is not important, but it is usual to choose a value at least five times the highest audio frequency, to prevent audible beat notes with the signal. The optimum amplitude of the bias varies with different wires, tapes and recording heads. Fortunately, it is easily found by experiment and is not very critical.

Using music as a test signal, as the "bias" is increased from zero, distortion rapidly diminishes, while the volume output rises to a maximum. Above this point, any

**Magnetic Recording Technique—** further increase in "bias" begins to reduce the volume level, and especially the high frequencies, although some further reduction in distortion may occur. A compromise has to be effected between

**Fig. 4. Suggested circuit for high-frequency bias oscillator, with connections to heads. 120 turns on a single lamination gives about 1mH.**

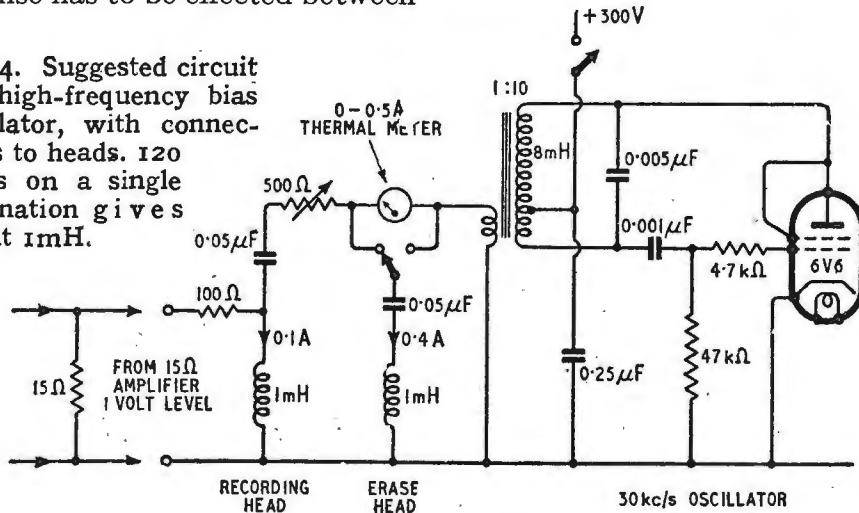

good high-frequency response and low distortion. Too high "bias" also makes erasure more difficult. Care must be taken during these tests to keep the recording level well below the overload point. Fig. 4 shows a typical oscillator circuit and connections.

**Noise.**—If a demagnetized wire or tape is run over a demagnetized playback head, clearly no signal voltages can be induced. If,

however, the medium is first passed over, say, a permanent magnet, then every discrete magnetic particle becomes magnetized and capable of inducing a noise voltage. For low noise levels it

men of wire or tape may be quiet when a.c.-erased, the noise-behind-the-signal on recording may be large, and impart a disagreeable fuzziness to the reproduction. The permanent-magnet test is a good one for checking the quietness of wires and tapes.

Assuming a quiet medium, unnecessary noise is often caused by slight permanent magnetization of the playback head. This may be demagnetized by applying "bias" to it from the oscillator and reducing this slowly to zero. Noise can also be caused by asymmetry of the "bias" waveform, which, in effect, produces a slight permanent magnetization. Even-harmonic distortion of the oscillator must be reduced to a minimum, and in this connection, to reduce loading effects, a Class "A" buffer amplifier is often interposed between oscillator and erase head, which generally requires rather a high power for complete erasure.

has been found that the diameter of these individual particles should not exceed about 0.0001in, that the size must be uniform and "clumping" of particles prevented. It is important to note that noise not only occurs when there is some permanent magnetic influence, but also during recording. Each cycle of signal is really an integration of noise voltages so that, although a bad speci-

While the foregoing notes are by no means exhaustive, they should at least enable the experimenter to obtain satisfactory results from the start. As with other systems of recording, perfection involves further careful experiment and measurements on the individual equipment in use.

## TELEVISION RECEIVER KIT

**T**HIS receiver is sold as a kit of parts by Premier Radio Company, 167, Lower Clapton Road, London, E.5, and an assembled model has been tested. There are separate vision- and sound-channel receivers, the former comprising four r.f. stages, diode detector, v.f. stage, d.c. restorer and phase-splitter, while the latter has two r.f. stages, double-diode-triode detector and a.f. amplifier, and a pentode output stage. The vision receiver is designed for single-sideband operation on the London transmissions, the sidebands remote from the sound channel being selected so that rejectors are not needed.

The tube is a 6-in electrostatic with a green screen and operates at about 2.3 kV. Each time base comprises a transitron-Miller integrator with a paraphase stage. Two valves are used for sync separation. The power supply is of the usual full-wave type, with a voltage-doubler using metal rectifiers for e.h.t.

On test the apparatus functioned well, the definition and synchronizing being good. The brightness is hardly sufficient for daylight view-

ing but is satisfactory for a darkened room. To anyone accustomed to the average television receiver, the small size of the picture and the green screen are unpleasant, but they are both things to which one rapidly becomes accustomed and must be considered as the inevitable

concomitants of the extremely low price of this kit—£17 17s.

The construction appears simple and comprises merely the assembly and wiring of the parts. The initial adjustments are few and do not appear to be at all difficult. A booklet describing the construction is available from the firm. A magnifying lens can be supplied at £1 19s 6d.

## ELECTRONIC COUNTER

"Scale - of - ten" counter recording up to 999,999 impulses, and pre-amplifier for use with Geiger-Muller tubes, made by Labgear, Willow Place, Fair Street, Cambridge. A stabilized e.h.t. unit for the tube bias is also available.

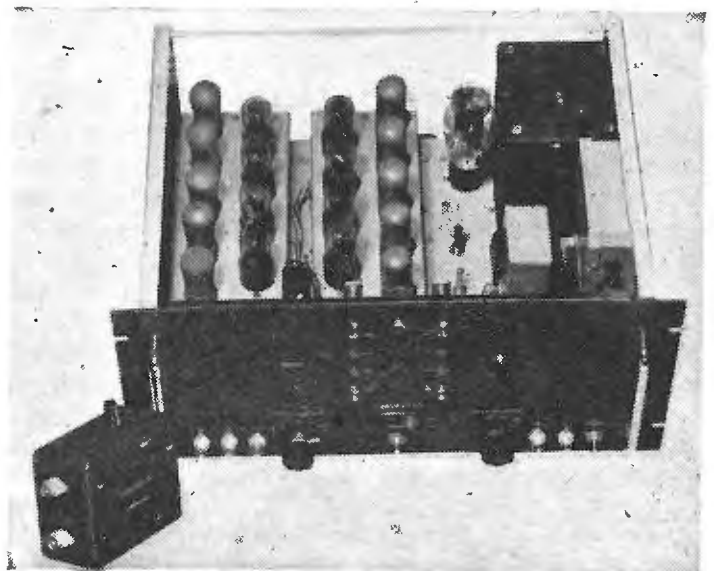



# HIGH-QUALITY AMPLIFIER: New Version

(Continued from page 287 of August issue)

**M**OST power amplifiers intended for sound reproduction are designed to have a uniform response to frequencies within the audible range, and it is the aim of designers of pickups, microphones and loudspeakers to give similar characteristics to their products. This represents an attempt to fulfil one of the conditions for the creation of a perfect replica of the original sound and provides a common basis for the design of individual units, which, when connected together, will provide a complete channel with a uniform gain/frequency characteristic.

Considerations of an engineering nature sometimes make it desirable, and even essential, to depart from this ideal of a uniform response in certain sections of equipment, and quite frequently the use of inferior equipment or long and unsuitable transmission lines, leads to an undesirable departure from uniformity. In cases like this, other "equalizer" units have to be inserted in the channel to provide characteristics which are the inverse of those of the offending section, so remedying the defect.

When listening conditions depart from the ideal—and this, unfortunately, happens frequently since most rooms are unsuitable auditoria for the reproduction of orchestral music at realistic intensities—it is sometimes beneficial to modify the frequency response characteristic of the equipment in an attempt to compensate for the more obvious defects in the room acoustics. The word "attempt" is used advisedly, since only very complex equalization could ever hope to provide accurate compensation for room acoustics. This question of the frequency compensation which is desirable when conditions depart

By **D. T. N. WILLIAMSON**

(Ferranti Research Laboratories)

from the ideal is a very thorny and subjective one. It provokes much heated, dogmatic, and usually very unscientific discussion, and is beyond the scope of the present article. It must suffice to say that the matter is one in which the individual must exercise his own judgment and act accordingly.

In order that he may have scope to do this, a pre-amplifier designed to be used in conjunction with gramophone recordings and

have occurred in that portion. Since it is impossible to determine the nature and amount of phase distortion by listening to a transmission, and since it is not usual for much attention to be paid to this form of distortion at the recording or transmitting end, there would seem to be little justification for the inclusion of phase correcting networks in domestic equipment. In the case of a sound reproducing system which is completely under the control of the user, particularly if stereophonic, phase distortion should not be allowed to occur if the finest possible quality is to be obtained. This is especially true at

low frequencies, where considerable time delays are involved. Low phase distortion is best achieved by designing a system with a bandwidth considerably greater than the audible range, but where this is not possible compensation

may be provided.

Consideration of the causes of frequency distortion leads to the conclusion that it is normal for the levels at the ends of the spectrum to be accentuated or attenuated progressively with respect to the level at middle frequencies and a form of compensation to correct this fulfils most requirements. It is not possible to lay down hard and fast rules about the amount of compensation necessary, but rates of attenuation or accentuation greater than 6 db/octave are not usually required.

As it is often desirable to change the amount of compensation during a programme without calling attention to the fact, methods which give continuous control over the response are to be preferred to switched systems, unless the latter are graded in very fine steps.

The use of inductors to provide gain/frequency compensation is

## Design of Tone Controls and Auxiliary Gramophone Circuits

radio transmissions should therefore be capable of providing variable compensation for such defects as are likely to occur in the source, and are capable of being ameliorated. In addition, fixed compensation must be provided for deviations from a uniform response which are deliberately introduced in gramophone records.

The degree of complication which is worthwhile in such a unit must be considered. In theory, it is possible to compensate precisely for deficiencies in the amplitude/frequency and phase/frequency response characteristics, but the equipment to do this is complicated and expensive. When a considerable portion of the channel is outside the control of the listener, as is the case when reproducing records or broadcast transmissions, he has no means, apart from the sensitivity and training of his ears, of determining the defects which

**High-Quality Amplifier—**

to be deprecated as, apart from possible troubles due to resonance effects and non-linearity, they are very liable to pick up hum from stray alternating magnetic fields, especially if they are air-cored. Metal- or dust-cored toroids are less troublesome in this respect, but are expensive and not readily obtainable.

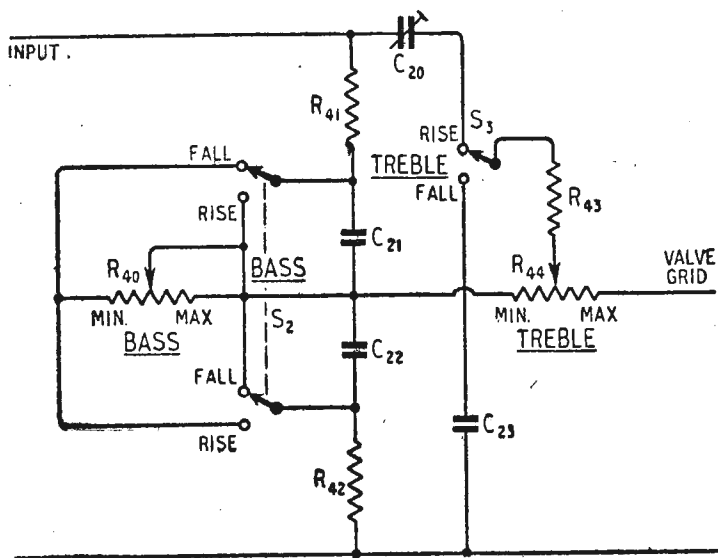

Fig. 5. Basic frequency compensation circuit. Typical values (for use after an EF37, triode-connected) are:  $R_{40}$ , 250k $\Omega$ , log;  $R_{41}$ , 100k $\Omega$ ;  $R_{42}$ , 6.8k $\Omega$ ;  $R_{43}$ , 10k $\Omega$ ;  $R_{44}$ , 100k $\Omega$  linear.  $C_{20}$ , 150pF max.;  $C_{21}$ , 0.01 $\mu$ F,  $C_{22}$  0.05 $\mu$ F;  $C_{23}$ , 1000pF.

**Frequency Compensation.**—Fig. 5 shows a simple compensation circuit which will accomplish bass and treble accentuation and attenuation without the use of inductors. The controls consist of two potentiometers, each associated with a changeover switch. Consider the low frequency controls  $R_{40}$  and  $S_2$ . When  $R_{40}$  is fully anticlockwise (minimum resistance) the response to frequencies below 1,000 c/s is uniform. If the switch  $S_2$  is set to "rise," as  $R_{40}$  is rotated clockwise, the amplitude/frequency characteristic will rise at low frequencies to the maximum shown at A in Fig. 6. If  $S_2$  is set to "fall" and  $R_{40}$  rotated clockwise from minimum position, progressive low-frequency attenuation will be introduced, up to the maximum shown at B. In a similar manner, by the use of  $R_{44}$  and  $S_3$  the high-frequency response is continuously variable from a level response to the extremes shown at C and D with the values given.

The attenuation introduced by the network when controls are at the level position is 24 db, and the network must, of course, be introduced into the system at a signal level such that the valve feeding it is not overloaded.

**Low - Pass Filter.**—The majority of medium - wave broadcast transmissions, when reproduced with wide-range equip-

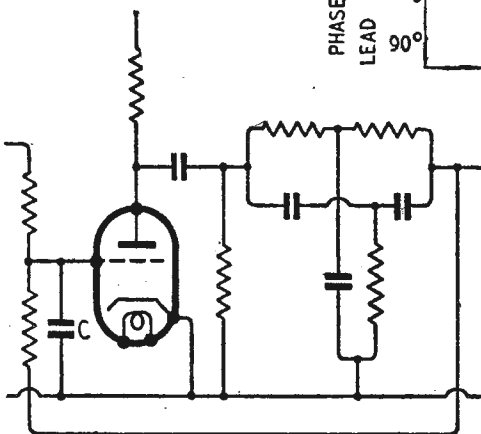

Fig. 7. Basic filter circuit.

ment, exhibit a most objectionable form of non-linear distortion. This takes the form of a

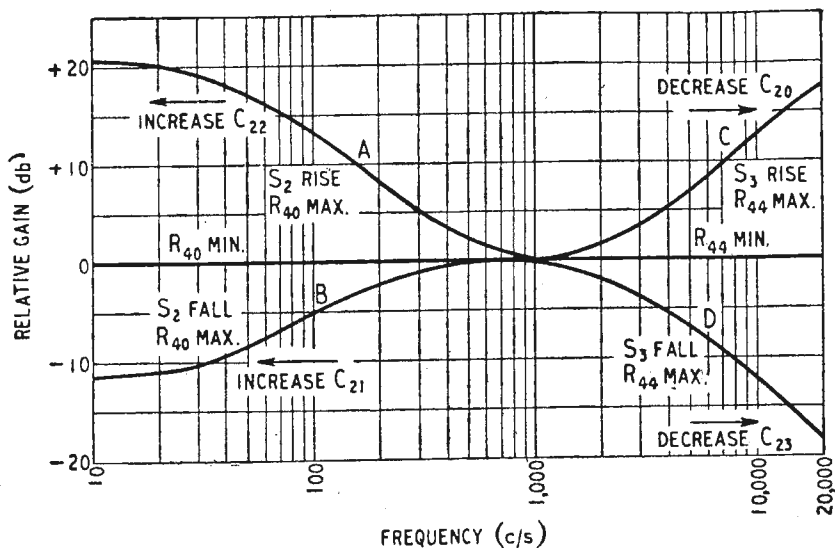

Fig. 6. Response curves of circuit of Fig. 5.

The curves may be shifted bodily along the horizontal axis by modifying the capacitance values as shown by the arrows in Fig. 6.

rattle or buzz often accompanying transient sounds such as piano-forte music. This type of distortion is commonly caused by minor discontinuities in the transfer characteristic and is frequently associated with Class "B" amplifiers.

Recording and processing defects, record wear and imperfect tracing by the pickup produce a similar type of distortion from gramophone records.

The most offensive frequency components of the rattle or buzz are generally present at

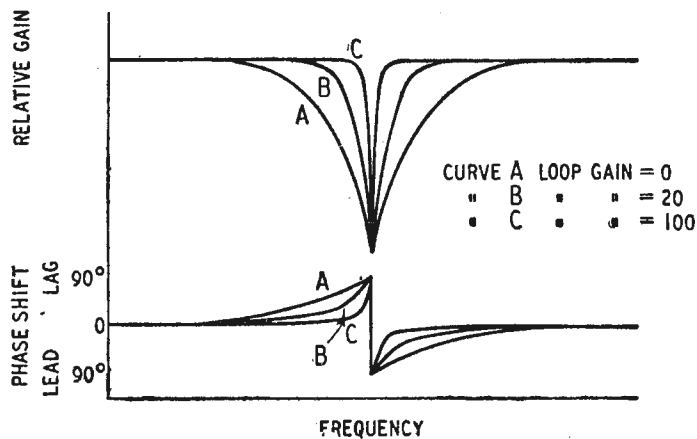

Fig. 8. Characteristics of circuit of Fig. 5.

the extreme upper end of the audible spectrum, and spread downwards as the severity of the effect increases. Fortunately, the concentration of this type of distortion into the extreme upper end of the spectrum makes it possible to effect considerable improvement by removing or reducing the energy in the signal at these frequencies. A low-pass filter with a cut-off frequency variable between the limits of 5 and 13 kc/s

and a fairly high rate of attenuation above the cut-off frequency is a great asset in securing the best possible aural result from indifferent transmissions or recordings.

Although it is practicable to provide a filter with a continuously variable cut-off frequency, the expense and complication are not normally justified and a switched selection of frequencies is satisfactory. To attain the high attenuation rates necessary to secure satisfactory results a normal resonant-section type of filter could be used, but this carries with it the disadvantages associated with the use of inductors.

An alternative type of filter

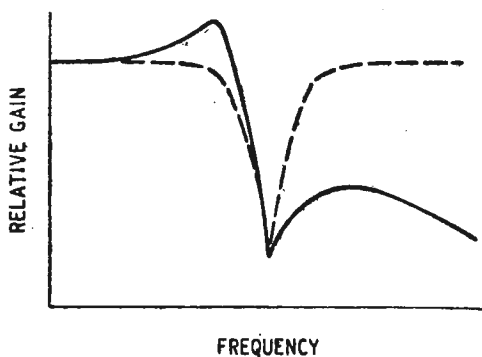

Fig. 9. Modification of basic filter characteristic produced by additional phase shift.

using only resistive and capacitive elements based on the parallel-T network<sup>1</sup> is capable of giving very satisfactory results. Briefly, the principle of this filter is as follows. In Fig. 7 is shown an amplifier feeding a parallel-T null network, the output from the network being fed back to the input of the amplifier. Such a system has amplitude and phase characteristics of the general shape shown in Fig. 8. By altering the loop gain of the amplifier, it is possible to produce a resonance characteristic of any desired degree of sharpness.

If now a lagging phase shift is introduced into the amplifier, for example, by connecting the capacitor C from grid to earth, it will be seen that the total phase shift due to network and amplifier just below resonance will be greater than 90° and the feedback voltage will have a positive component, whilst above resonance a greater negative component will exist. The effect of this is to un-

balance the amplitude characteristic as shown in Fig. 9. A rise in response occurs just before the resonance frequency due to the positive component of feedback,

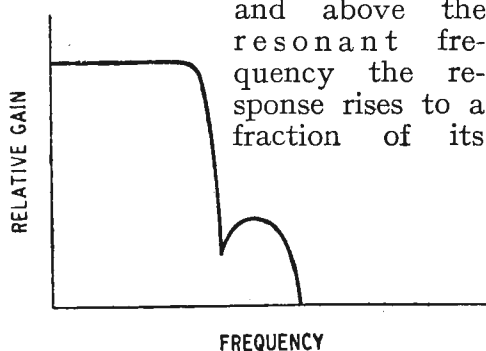

Fig. 10. Final low-pass characteristic resulting from addition of external R-C attenuator.

value below resonance and then falls off due to the attenuation produced by the capacitor C.

The addition of a further R-C attenuating network external to the circuit will produce a frequency response characteristic as shown in Fig. 10. The similarity of this curve to the response of a resonant element L-C filter will readily be appreciated. There is a practical limit to the rate of attenuation which can be achieved with a single stage, since the attenuation rate and the level to which the response rises above the frequency of maximum attenuation are interrelated. Thus a high rate of attenuation is achieved

a minimum attenuation above cut-off of nearly 30db, which is quite satisfactory. By cascading a number of these filter stages any desired attenuation characteristics may be achieved, and high-pass filters may be similarly formed by the addition of leading phase shift to the amplifier.

A filter designed on these lines, with five switched positions giving nominal cut-off frequencies of 5, 7, 10 and 13 kc/s and a "linear" position is incorporated in the final circuit. The performance is shown in Fig. 11.

**Gramophone Pre-amplifier.** —

The arrangements just described are generally all that is necessary to compensate for defects in radio transmissions. For record reproduction, however, additional fixed compensation is required. The nature of this compensation will depend on the recording characteristic and the type of pickup used.

For reasons now too well known to require repetition, lateral disc recordings are usually cut with a groove amplitude which is proportional to signal below some arbitrarily selected frequency in the 300-400 c/s region and with a lateral groove velocity which is proportional to signal above this frequency. To improve signal/noise ratio it is now common practice to increase the level recorded

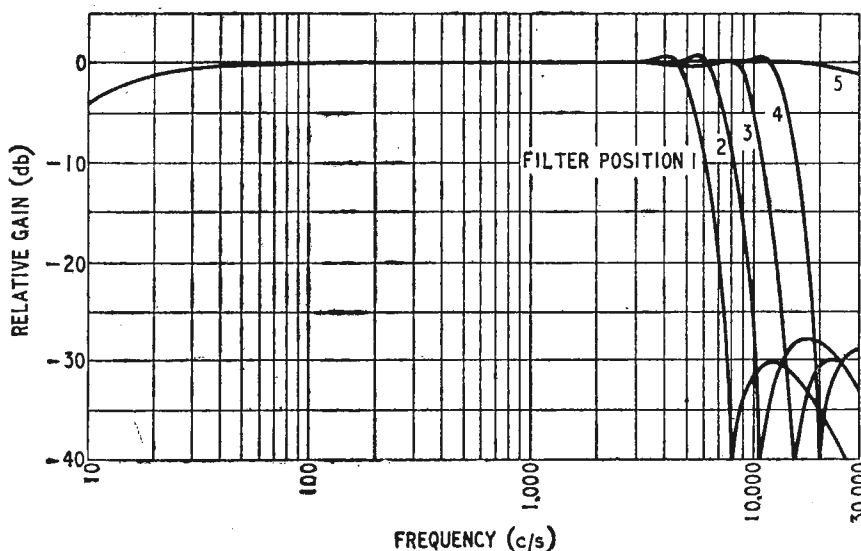

Fig. 11. Measured overall response of low-pass filter, in conjunction with pre-amplifier circuit to be described in a subsequent instalment.

with simplicity only at the expense of a low ratio of response below cut-off to peak response above cut-off. However, a rate of attenuation of 40db/octave can be obtained from one stage with

at high frequencies. This is particularly effective, since the noise energy per cycle increases with frequency due to the structure of the record material. In Fig. 12 is shown the recording characteristic

<sup>1</sup> Thiessen, G. J. "R-C Filter Circuits." *Journal of the Acoustical Society of America*. Vol. 16, No. 4, pp. 275-279 April, 1945.

**High-Quality Amplifier—**

used by Decca. The E.M.I. characteristic does not differ substantially at low frequencies but the rise above 3,000 c/s is absent. It is proposed to use the Decca characteristic as a basis for design. When playing E.M.I. recordings, one fixed capacitor in the pre-amplifiers to be described later may be switched out of circuit, giving a level response. Alternatively the gramophone pre-amplifier may be left unchanged and correction provided by means of the variable treble control in the tone compensation unit. This, when  $C_{20}$  is set to 100 pF and  $R_{44}$  (Fig. 5) advanced by one quarter of maximum rotation, gives almost perfect correction.

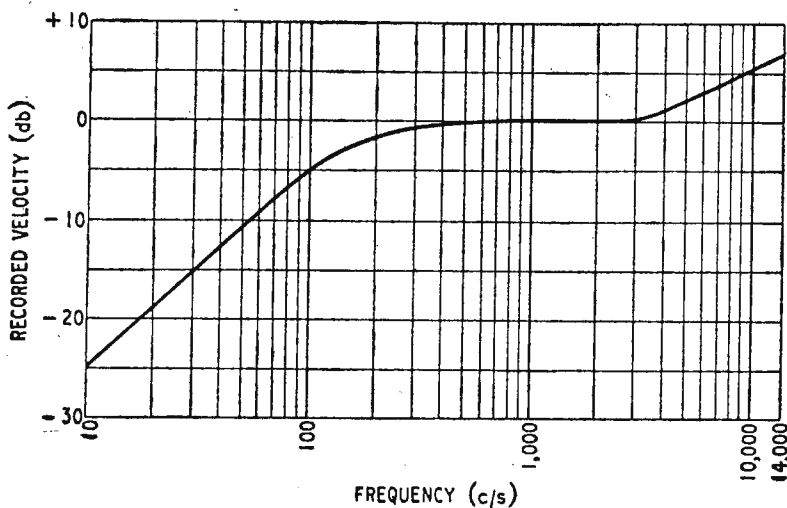

Fig. 12. Decca recording characteristic.

The majority of pickups, with the exception of piezoelectric types, give an electrical output which is proportional to the lateral velocity of the stylus. The output of such a pickup when playing a Decca recording will be of the form shown in Fig. 12, with ordinates of voltage instead of velocity. A pre-amplifier suitable for such a pickup should have a frequency characteristic which is the inverse of this.

Some desirable properties of a pickup pre-amplifier are:—

1. Low noise level.
2. Low distortion at signal levels likely to be encountered with pickups in common use.
3. Sharp attenuation below 20 c/s to suppress turntable rumble, etc.
4. Provision for varying the gain electrically.

**Noise Level.**—The attainment of a low noise level in high-quality

sound systems is of such vital importance that a few remarks of a general nature will not be out of place at this juncture.

It is an unfortunate fact that improvements in microphones and pickups in the direction of wider frequency range and absence of other forms of distortion are almost invariably achieved at the expense of the electrical output. This does not necessarily mean that the efficiency of the transducer is reduced by the other improvements, but merely that it removes less energy from the acoustical field or from the record groove which actuates it, causing less disturbance of this field, or less wear of the record groove.

There is, however, a limit to

ratio of 70 db, a sound reproducing system with a frequency response flat to 20,000 c/s operating at a realistic volume level produces, in the absence of a signal, noise which is just audible as a very gentle rustle and is completely inoffensive.

Most modern microphones and pickups are electromagnetic, although there is a tendency for microphone design to gravitate towards carrier-operated capacitor types. These have problems of their own and will not be treated here. Electromagnetic microphones and pickups are manufactured with impedances ranging from a few milliohms to several thousand ohms, but are normally used in conjunction with a transformer which raises the impedance to a suitably high value to match the input impedance of a valve.

For obvious reasons it is desirable to make this secondary impedance as large as possible—say several megohms—since the voltage output from the transducer will increase simultaneously, reducing the gain required from the electronic equipment and the amount of noise contributed by it.

It is not practicable, however, to increase the secondary impedance much beyond 0.1 MΩ if a flat frequency response is required from the transformer over the audible range.

The noise generated by thermal agitation in a 0.1 MΩ resistor at room temperature is about 6 μV for a bandwidth of 20,000 c/s. To this must be added the noise produced in the first valve of the amplifier. By careful design and construction, and by the use of a suitable valve, the noise from all causes, including mains hum, can be reduced to a value equivalent to about 3 μV at the grid, but under normal conditions a figure of 5 μV is fairly representative. The total noise may be taken as the square root of the sum of the squares of these values, or about 8 μV. To obtain a signal/noise ratio of 70 db, then, the peak signal must be 70 db above this level, say 25 mV r.m.s.. The pre-amplifier should have sufficient gain to enable the main amplifier to be fully loaded by a signal at this level.

The choice of a valve type for the first stage must be made carefully. In theory, for equal gain

this tendency set by the noise generated by thermal agitation in the transducer and its auxiliaries and by the noise produced in the first valve of the amplifier. It is desirable in a wide-range, high-quality sound system to attempt to maintain a peak signal/noise ratio of at least 70 db. This figure represents the best that can be achieved with a direct cellulose disc recording when everything is "just right," and it is to be expected that the standards of commercial disc recordings will approach this level when improved techniques are combined with new disc materials. A well-designed magnetic tape recorder will give a signal/noise ratio of 70-80 db, and the increasing use of this type of equipment will doubtless give impetus to the research necessary for the achievement of similar standards in other forms of recording. With a signal/noise

the noise level in a triode stage is lower than that produced by a pentode, since the pentode has an additional noise component due to electron partition between screen and anode. In fact, however, there are no high-gain triodes commercially available with the requisite characteristics and electrode structures for low-noise operation. A valve designed for such conditions should have a rigidly braced electrode structure to reduce microphony and a balanced "double helical" heater construction to minimize the alternating field surrounding the cathode. The Mullard EF37 has this construction and, connected as a pentode, the noise levels mentioned earlier are obtainable. Before commencing work, the reader who is not familiar with the technique of high-gain amplifier construction should consult an article on this subject.<sup>2,3</sup> Considerable reduction of residual hum may usually be obtained by demagnetizing the valve.<sup>4</sup> In order to obtain the best signal/noise ratio, the principle which should be followed, when valve noise is the limiting factor in high-gain amplifiers, is to put the whole of the available signal into the valve grid, and to provide any frequency compensation which may be necessary after the signal has been amplified. By this method valve noise is included in any attenuating operations which may be performed and the overall signal noise ratio is improved.

**Low Distortion.** — Numerous methods of providing a response which varies with frequency are possible and, of course, each method has advantages and disadvantages. Where the response has to be continuously variable the method which gives greatest simplicity of control usually triumphs. Other things being equal, however, methods which employ selective negative feedback are to be preferred, as circuits of this nature generally have a high signal-handling capacity and non-linear distortion is kept to a minimum. In a pickup pre-

amplifier this may be of importance where pickups with widely varying output levels are to be used.

**High - Pass Characteristic.** — Gramophone motors tend to produce vibrations which can cause unpleasant rumbling noises in a wide-range system. Although the energy contained in the "rumble" components may be relatively low, the frequency is also very low, and consequently loud-speaker cone movements of high amplitude may be caused. If the driving coil should move out of the region of uniform flux-density, the whole spectrum being reproduced will be distorted in a particularly unpleasant manner. Distortion in the output transformer is also possible.

This situation can be improved materially by the insertion of a high-pass filter with a cut-off frequency of about 20c/s and a fairly rapid attenuation below cut-off. At these low frequencies, such filters are conveniently composed of resistance-capacitance networks and may be incorporated in the bass-compensation pre-amplifier.

**Electrical Fading Control.** — When the pickup is placed on, or removed from, the disc the gain must be reduced to avoid unpleasant noises. While this may be done by a mechanical potentiometer the method is clumsy and does not facilitate rapid record changing. It has been found convenient to employ an electrical method in which the gain of one of the stages is reduced to zero at the flick of a switch by a bias voltage applied and removed by means of a network with a suitable time constant.

(To be continued)

## NEWS FROM THE CLUBS

**Birmingham.**—The annual dinner of the Midland Amateur Radio Society will be held at the Imperial Hotel, Birmingham, on October 15th, at 6.30. Sec.: A. W. Rhodes, 135, Woolmore Road, Birmingham, 23, Warwicks.

**Eastbourne.**—Meetings of the Eastbourne and District Group of the R.S.G.B. are held on the first Friday of each month at the Friends' Meeting House, Wish Road, Eastbourne. Sec.: R. F. Nugent, Field House, Windmill Hill, nr. Hailsham, Sussex.

**Luton and District Radio Society** meets each Monday at 7.30 at Surrey Street School. Sec.: H. S. E. Radford, 37, Wilsden Avenue, Luton, Beds.

**Richmond.**—The formation of the Richmond and District Radio Society is proposed and the inaugural meeting will be held at the Station Hotel, Richmond, at 7.30 on October 5th.

**Southend.**—The fortnightly meetings of the Southend and District Radio Society recommence on October 7th at 7.15 in Room 1, at the Municipal College. Sec.: J. H. Barrance, M.B.E. (G3BUJ), 49, Swanage Road, Southend-on-Sea, Essex.

**Southport.** — In addition to the monthly meetings of the Southport Radio Society, which are held on the third Monday in each month at 8 p.m. at the headquarters, 38a Forest Road, the club premises are open every Monday and Wednesday evening. Sec.: F. H. P. Cawson, 113 Waterloo Road, Southport, Lancs.

**Spenn Valley Radio and Television Society** meets on alternate Wednesdays at the Temperance Hall, Cleckheaton at 7.30. The subjects to be discussed at the meetings on October 12th and 26th are "Measurements and the Radio Amateur" and "Some Aspects of Television." Sec.: N. Pride, 100 Raikes Lane, Birstall, nr. Leeds, Yorks.

**Sunderland.**—Meetings of the Sunderland Radio Society are held at Prospect House, Prospect Row. On October 19th, B. A. Holden, M.A., will speak on "Quality Disc Reproduction" and on October 26th J. M. Carter, B.Sc., will demonstrate the Wright and Weaire magnetic tape recorder. Both meetings begin at 8 p.m. Sec.: C. A. Chester, 38 Westfield Grove, High Barnes, Sunderland.

## RADIATION MONITOR

Both visual and aural indication of pulses from a Geiger-Muller tube are given in this instrument, the meter being arranged to indicate "rate of count". A stabilized power supply is included and the overall accuracy is within  $\pm 1$  per cent. Alpha and beta-gamma probe units are available. The makers are Airmec Laboratories, High Wycombe, Bucks.

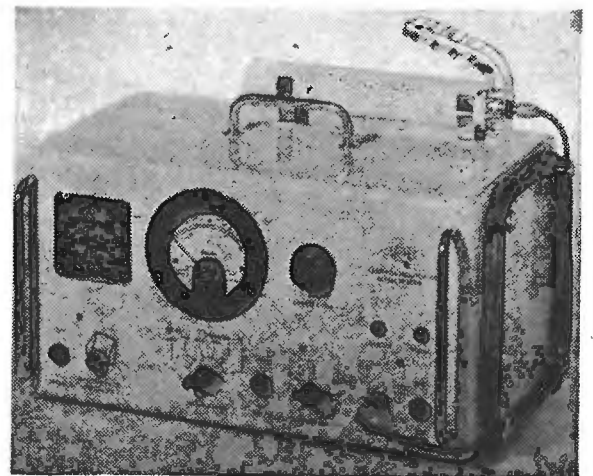

<sup>2</sup> Baxandall, P. J., "Hum in High Gain Amplifiers," *Wireless World*, Vol. 53, No. 2, pp. 57-61, February, 1947.

<sup>3</sup> Dickerson, A. F., "Hum Reduction," *Electronics*, Vol. 21, No. 12, p. 112, December, 1948.

<sup>4</sup> Correspondence. *Electronic Engineering*, Vol. 20, No. 245, p. 235, July, 1948; No. 248, p. 339, October, 1948; No. 250, p. 406, December, 1948.

# MICROWAVE LENSES

## A General Survey of the Three Main Types

By **C. SUSSKIND**, M.Eng., B.Sc., Assoc.Brit.I.R.E.  
(Yale University, U.S.A.)

**R**ADIO waves are essentially of the same nature as light waves. Both are electromagnetic radiation phenomena which differ merely in frequency. At microwave frequencies (*e.g.*, in radar work) the wavelengths—and hence the antenna dimensions—are of the order of only a few centimetres. Accordingly, certain optical analogies suggest themselves. The most widely used device for producing a beam of light, for instance, is the parabolic mirror; if the source is located at the focus, the rays will be reflected parallel to the axis. This arrangement will work equally well for microwaves, provided a conducting surface is substituted for the mirror.

The parabolic "dish" antenna has certain disadvantages, however: the source is in the path of the beam and distorts it by virtue of a shadow effect, in addition to interference introduced as a result of forward radiation directly from the source; there is ample opportunity for radiation in the backward direction, past the reflector, with the attendant loss of energy and possibility of interference with nearby radiators ("cross-talk"); some energy is reflected back into the feed and may disturb the source; and furthermore, the tolerances required in the construction of the reflector are very small.

These difficulties can be obviated if the reflector is replaced by a large lens<sup>1,2,3</sup>, made of glass, polystyrene, or some other dielectric material, and placed in front of the source. The source, which is no longer in the beam path, is now made to radiate in the forward direction; the two surfaces give the designer an additional degree of freedom; the possibility of distortion due to warping is greatly reduced; and

it can be shown<sup>4</sup> that the tolerances required are four to five times greater than for the parabolic reflector.

The solid lens may, on the other hand, present a considerable mismatch at its surface, and consequently cause loss of gain and interference (scattering). This mismatch may be reduced by the use of quarter-wavelength sheets: the lens surfaces are covered by a sheet consisting of another dielectric, the thickness of which is adjusted so that the waves reflected from it and from the surface proper cancel out.<sup>4</sup>

A more serious disadvantage of the solid dielectric lens is its

weight: a lens of a size useful in practical applications would be very heavy indeed. To circumvent this difficulty, Kock<sup>5,6</sup> in America and Rust<sup>7</sup> in Britain have each independently suggested the use of parallel-plate configurations.

### Metal Plate Lenses

Two semi-infinite, parallel metal strips constitute a very simple form of waveguide. The velocity with which a surface of constant phase propagates (phase velocity) between parallel plates of separation  $h$  is given by

$$v_p = \frac{v_0}{\sqrt{1 - \left(\frac{m\lambda}{2h}\right)^2}} \quad \dots \quad (1)$$

where  $v_0$  is the phase velocity in free space,  $m$  the order of the mode being propagated, and  $\lambda$  the wavelength. The wave will be propagated without attenuation only if

$$h > \frac{m\lambda}{2} \quad \dots \quad (2)$$

Thus the phase velocity  $v_p$  between the plates is always greater than the velocity  $v_0$  in free space. If a set of parallel plates (arranged parallel to the direction of electric intensity  $\mathbf{E}$ ) having the shape shown in Fig. 1(a) is used, it is seen that the phase velocity will be increased along paths where the plates are wide, and unaffected where the plates have zero width. Thus the equiphase surfaces (shown dotted), spherical to the left of the lens, will emerge as planes from the lens; this is the

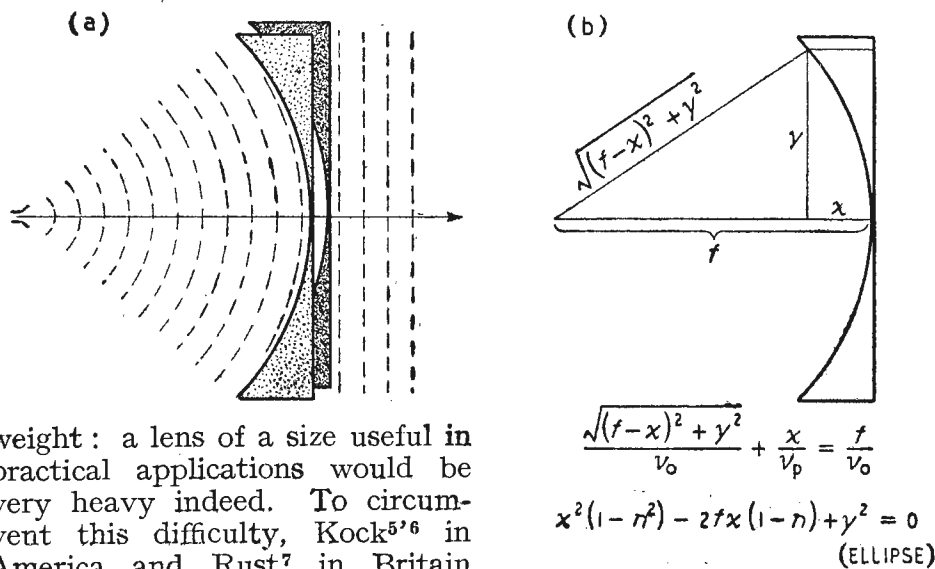

Fig. 1. Metal plate lens element.

condition which will yield maximum gain and directivity.

To determine the contour of this lens, the times required for two points on the same equiphase surface to travel along two different paths (*cf.* Fig. 1(b)) are equated. Using the terminology of optics, the ratio of the two phase velocities

$$n = \frac{v_p}{v_0} = \sqrt{1 - \left(\frac{m\lambda}{2h}\right)^2} \quad \dots \quad (3)$$

may be considered to represent an

equivalent index of refraction. (Note that  $n < 1$  for this construction.) The equation obtained for the contour of a lens element is that of an ellipse. If the spherical wave emerging from a point source is to be converted into a plane wave by passing through the lens, an ellipsoid of

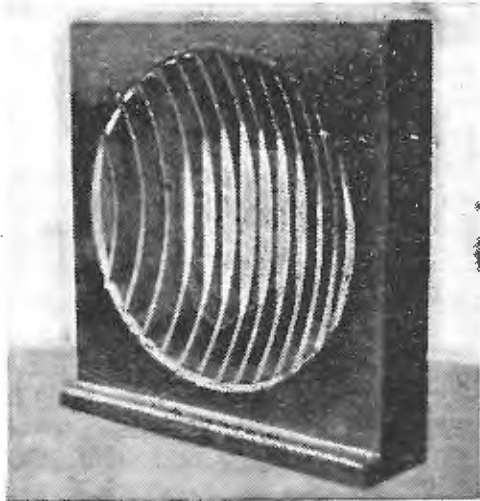

Fig. 2. Metal plate lens for  $\lambda = 3$  cm.

revolution is actually required. The system may, of course, be used conversely as a receiver antenna by allowing a plane wave to impinge upon the flat surface and to be focused to a point.

A metal plate lens constructed at the Dunham Laboratory of Electrical Engineering, Yale University, is shown in Fig. 2. This lens, designed for operation at 3 cm, has a focal length of  $18\frac{1}{2}\lambda$ , an aperture of  $11\lambda$  (and hence an  $f$ -number of  $5/3$ ), and an effective index of refraction  $n = 0.6$ .

The most obvious disadvantage of the metal plate lens is evident from equation (3): it is the dependence of the equivalent index of refraction on the wavelength (or frequency). Experimental results<sup>5</sup> show that a useful bandwidth of not more than 5 per cent of the operating frequency can be achieved. This important limitation has led to the development of a broad-band lens at the Bell Telephone Laboratories<sup>8,9,10</sup>, in which so-called artificial dielectrics are utilized.

### Artificial-Dielectric Lenses

When an ordinary dielectric is placed into an electric field  $\mathbf{E}$ , the dielectric is polarized to the extent  $\mathbf{P} = N\alpha_e\mathbf{E}$ , where  $N$  is

the number of molecules per unit volume, and  $\alpha_e$  the polarizability (always positive). It is customary to define a displacement vector  $\mathbf{D} = \epsilon\mathbf{E} = \epsilon_0\mathbf{E} + \mathbf{P}$  where  $\epsilon$  is the permittivity of the dielectric and  $\epsilon_0$  the permittivity of free space ( $\epsilon_0 = 8.85 \times 10^{-12}$  farad/metre in the m.k.s. system of units). Thus the permittivity is given by

$$\epsilon = \epsilon_0 + N\alpha_e \dots \dots (4)$$

and the dielectric constant is given by the ratio

$$\kappa_e = \frac{\epsilon}{\epsilon_0} = 1 + N\frac{\alpha_e}{\epsilon_0} \dots (5)$$

Similarly, the magnetic permeability is given by

$$\mu = \mu_0 + N\alpha_m \dots (6)$$

where  $\mu_0$  is the permeability of free space ( $\mu_0 = 4\pi \times 10^{-7}$  henry/metre in the m.k.s. system) and  $\alpha_m$  the magnetic polarizability (may be positive or negative). The relative permeability is given by the ratio

$$\kappa_m = \frac{\mu}{\mu_0} = 1 + N\frac{\alpha_m}{\mu_0} \dots (7)$$

The polarizabilities  $\alpha_e$  and  $\alpha_m$  can be calculated for various geometric configurations; their values may be found in many advanced textbooks. The general shape of a molecule is usually assumed to be spherical; for a sphere,  $\alpha_e = 4\pi\epsilon_0a^3$  and  $\alpha_m = -2\pi\mu_0a^3$  where  $a$  is the sphere radius.

The index of refraction is given by

$$n = \sqrt{\kappa_e\kappa_m} \dots \dots (8)$$

and is independent of frequency in the region where the wavelength is large compared with the size of the particles and the spacing between them.

It is found that an analogous artificial dielectric can be constructed by reproducing the molecular structure on a macroscopic scale; such a dielectric may consist of a lattice of metal spheres having a radius and separation which are small compared with the wavelength.

Fig. 3. Artificial-dielectric lens (cross-section)

The artificial dielectric will have the properties described by equations (4) to (8), inclusive. Thus a lens like that in Fig. 3(a) may be constructed from small metal

spheres supported as shown. This lens will have the shape and action of a solid dielectric lens, and yet retain the weight advantage of the metal plate lens. Furthermore, the artificial-dielectric lens will have an index of refraction  $n = v_0/v_p$  which is essentially independent of frequency, except in the range where the size and separation of the elements become comparable with the wavelength.

To determine the contour of this lens, a procedure similar to that described in the case of the metal plate lens is followed. A comparison of paths (cf. Fig. 3(b)) yields the equation of a hyperbola; to transform the spherical waves emanating from a point source into plane waves, a hyperboloid of revolution is needed. It should be noted that the index of refraction  $n = v_0/v_p$  will be greater than 1 for artificial dielectrics, since here  $v_0 > v_p$ . This relationship accounts for the difference between the shapes of the metal plate lens previously described and the artificial-dielectric lens. The action of the latter is to delay the portion of the wavefront passing through the middle of the lens with respect to that passing through the edge, and this lens is therefore sometimes designated as a "delay lens."

The index of refraction of an artificial dielectric consisting of small spheres (radius  $a$ ) is given, from equation (8), by

$$n = \sqrt{(1 + 4\pi N\alpha_e)(1 - 2\pi N\alpha_m)} \quad (9)$$

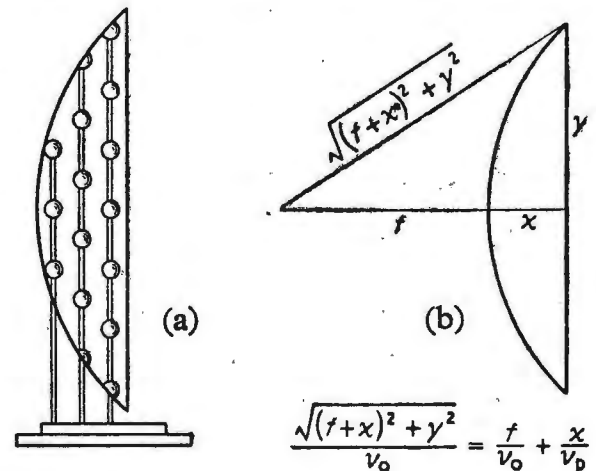

$$\frac{\sqrt{(f+x)^2 + y^2}}{v_0} = \frac{f}{v_0} + \frac{x}{v_p}$$

$$x^2(n^2 - 1) + 2fx(n - 1) - y^2 = 0$$

(HYPERBOLA)

where  $N$  is the number of spheres per unit volume. It is seen that the value of  $n$  is reduced by the factor introduced in the second bracket under the radical. This

**Microwave Lenses—**

reduction can be eliminated if particles are used which are thin in the direction of propagation, and thus do not disturb the magnetic field. For such elements the index of refraction is given simply by,

$$n = \sqrt{\kappa_e} = \sqrt{1 + N \frac{\alpha_e}{\epsilon_0}} \quad \text{.. (10)}$$

The spheres of Fig. 3(a) are replaced by thin metal discs lying in vertical planes which are normal to the plane of the paper. Such a lens was first proposed by Kock<sup>8</sup>. The discs may be made of copper foil and affixed to thin slabs of polystyrene foam.\* The polarizability of a disc of radius  $a$

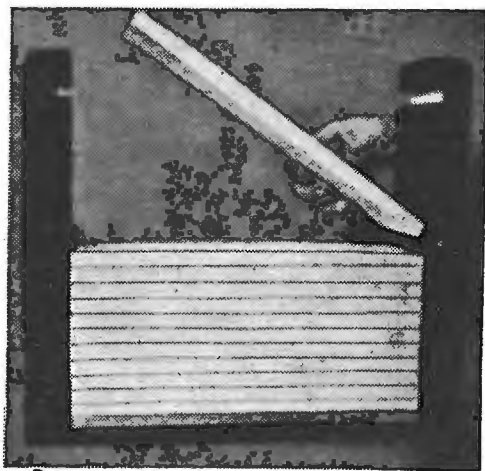

Fig. 4. Artificial-dielectric lens (metal strip type) being assembled.

is given by  $\alpha_e = 16\epsilon_0 a^3/3$  and the index of refraction is accordingly

$$n = \sqrt{1 + \frac{16}{3} a^3 N} \quad \text{.. (11)}$$

where  $N$  is the number of discs per unit volume. This lens, like the lens consisting of spherical elements, will beam waves of any arbitrary polarization, provided the elements are arranged isotropically.

If waves of only a single polarization need be considered, metal strips may be substituted for the discs. With reference to Fig. 3, these strips would extend horizontally, standing on edge in a vertical plane normal to the plane of the paper. One way of constructing such a lens is to stack "Styrofoam" slabs as shown in Fig. 4. Each slab is milled to accept

\* This material, known commercially as "Styrofoam" and manufactured by the Dow Chemical Company, has found wide application in antenna work because it is very light (yet comparatively rigid) and has a dielectric constant which differs only very slightly from that of freespace.

metal strips of varying lengths (cf. Fig. 5) and arranged to give the desired hyperbolic contour. The polarizability of a strip of

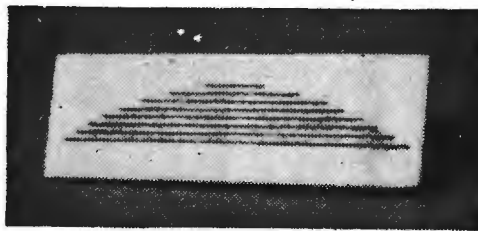

Fig. 5. Element or metal strip type lens.

width  $d$  is given by  $\alpha_e = \pi\epsilon_0 d^2/4$  and the index of refraction is therefore

$$n = \sqrt{1 + \frac{\pi d^2 N}{4}} \quad \text{.. (12)}$$

where  $N$  is now the number of strips per unit area, looking on edgewise.

The assembled lens is shown in Fig. 6; designed for operation at 3 cm, it has a focal length of  $17\lambda$  and an index of refraction of  $n = 1.375$ .

The Bell Telephone Company's microwave relay systems at present utilize both the metal plate and the artificial-dielectric lens: the former on the New York-Boston line, and the latter on the New York-Chicago line.

**Path-Length Lenses**

Since the above was written, still another type of delay lens



Fig. 6. Artificial-dielectric lens fully assembled.

has been developed at the Bell Telephone Laboratories: the path-length lens<sup>11</sup>. This lens, which has the over-all hyperbolic contour of Fig. 3(b), comprises corrugated metal plates arranged horizontally, or flat plates supported at an

angle with the horizontal. Either arrangement serves to "delay" the part of the wavefront passing through the centre of the lens with respect to that passing through the edge, thus giving focusing action. The main advantage of the new lens, as compared with the delay lens previously described, is simpler construction. The path-length lens retains the broadband characteristics of the earlier type and even improves upon them at the high-frequency end by eliminating dispersion and refraction; the only requirement is that the vertical spacing between the plates must be smaller than  $\lambda/2$  for the highest frequency desired.

**REFERENCES**

- <sup>1</sup> Friedlander, F. G., "A dielectric-lens aerial for wide-angle beam scanning," *J.I.E.E.*, Pt. IIIA, Vol. 93, p. 658, 1946.
- <sup>2</sup> Wilkes, G., "Lenses having a dimension of the order of a wavelength," *C. R. Acad. Sci. (Paris)*, Vol. 223, p. 1116, 1946.
- <sup>3</sup> Wilkes, G., "Wavelength lenses," *Proc. I.R.E.*, Vol. 36, p. 206, 1948.
- <sup>4</sup> Fry, D. W., "Some recent developments in the design of centimetric aerial systems," *J.I.E.E.*, Pt. IIIA, Vol. 93, p. 1497, 1946.
- <sup>5</sup> Kock, W. E., "Metal-lens antennas," *Proc. I.R.E.*, Vol. 34, p. 828, 1946.
- <sup>6</sup> Kock, W. E., "Radio lenses," *Bell Lab. Rec.*, Vol. 24, p. 193, 1946.
- <sup>7</sup> Rust, N. M., "The phase correction of horn radiators," *J.I.E.E.*, Pt. IIIA, Vol. 93, p. 50, 1946.
- <sup>8</sup> Kock, W. E., "Metallic delay lenses," *Bell Syst. Tech. Jour.*, Vol. 27, p. 58, 1948.
- <sup>9</sup> Kock, W. E., "Artificial dielectric lenses for microwaves," *Bell Lab. Rec.*, Vol. 26, p. 145, 1948.
- <sup>10</sup> Kock, W. E., "Broadband lens antenna for microwaves," *Electronics*, Vol. 21, p. 108 (April), 1948.
- <sup>11</sup> Kock, W. E., "Path-length microwave lenses," *Proc. I.R.E.*, Vol. 37, p. 852, 1949.

"Electrons in Triodes," the second of a series of educational booklets being produced by Ediswan, is now available gratis to radio societies, education authorities and other bona fide bodies. This 48-page booklet outlines briefly the historical development of the triode and gives an explanation of its working principles. The first booklet in the series covered diodes and subsequent issues will deal with screened grids, pentodes, beam tetrodes, frequency changers and multiple diodes. Requests for copies should be sent to the Ediswan Electric Co., 155, Charing Cross Road, London, W.C.2.



# AT LAST— BETTER ALL-DRY MINIATURES

**1R5**  
Heptode Frequency  
Changer

**1S4**  
Battery Beam Tetrode

**1S5**  
Battery Diode Pentode

**3S4**  
Battery Beam Tetrode

**1T4**  
Battery Pent. Vari-Mu

**3V4**  
Battery Beam Tetrode

Type Number	Application	Heater		Anode Voltage Normal	Screen Voltage Normal	Grid Voltage Normal	Anode Current mA	Screen Current mA	Impedance Ohms	Mutual Conductance mA/V	Optimum Load Ohms	Power Output Watts
		Volts	Amps.									
1T4	Batt. Pent. Vari-Mu	1.4	0.05	90	67.5	0/-16	3.5	1.4	500,000	0.9	—	—
1R5	Heptode F.C.	1.4	0.05	90	67.5	0/-14	1.6	3.2	600,000	300*	—	—
1S4	Batt. Beam Tetrode	1.4	0.1	90	67.5	-7	7.4	1.4	100,000	1.58	8000	0.27
1S5	Batt. Diode Pentode	1.4	0.05	90	67.5	0	1.6	0.4	600,000	0.63	—	—
3S4	Batt. Beam Tetrode	1.4 2.8	0.1 0.05	90	67.5	-7	7.4	1.4	100,000	1.58	8000	0.27
3V4	Batt. Beam Tetrode	1.4 2.8	0.1 0.05	90	90	-4.5	9.5	2.1	100,000	2.15	10000	0.27

\* Conversion Conductance in Micromhos.

**G**REATLY advanced engineering techniques have enabled us to produce *ALL-DRY* Miniatures that are better in every way. Every valve is individually **RECEPTION TESTED** and bears this identifiable seal.

BRIMAR *ALL-DRY* Miniatures are suitable for every modern All-Dry Portable.

Full details of their characteristics are shown in the table above.

## BRIMAR

### ALL-DRY MINIATURES

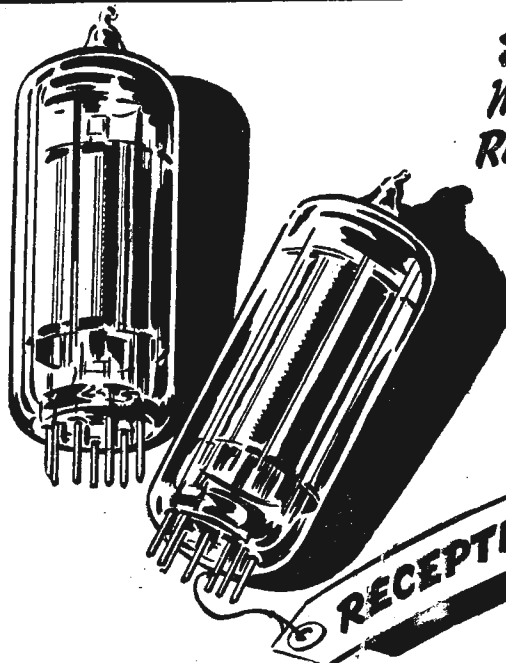

Meet us at  
**RADIOLYMPIA**  
Sept. 28-Oct. 8

**RECEPTION TESTED**

**STANDARD TELEPHONES AND CABLES LIMITED, FOOTSCRAY, SIDCUP, KENT.**

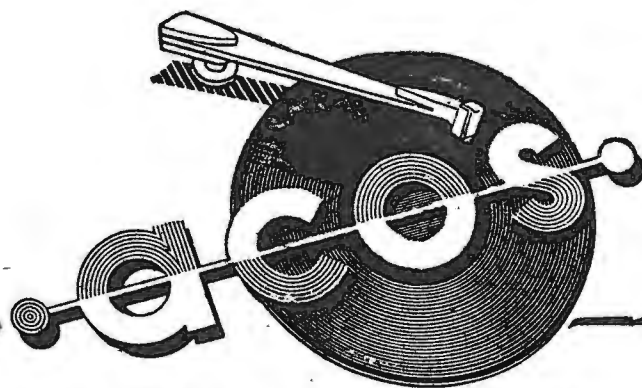

PRESENTS

## NEW TRUE FIDELITY

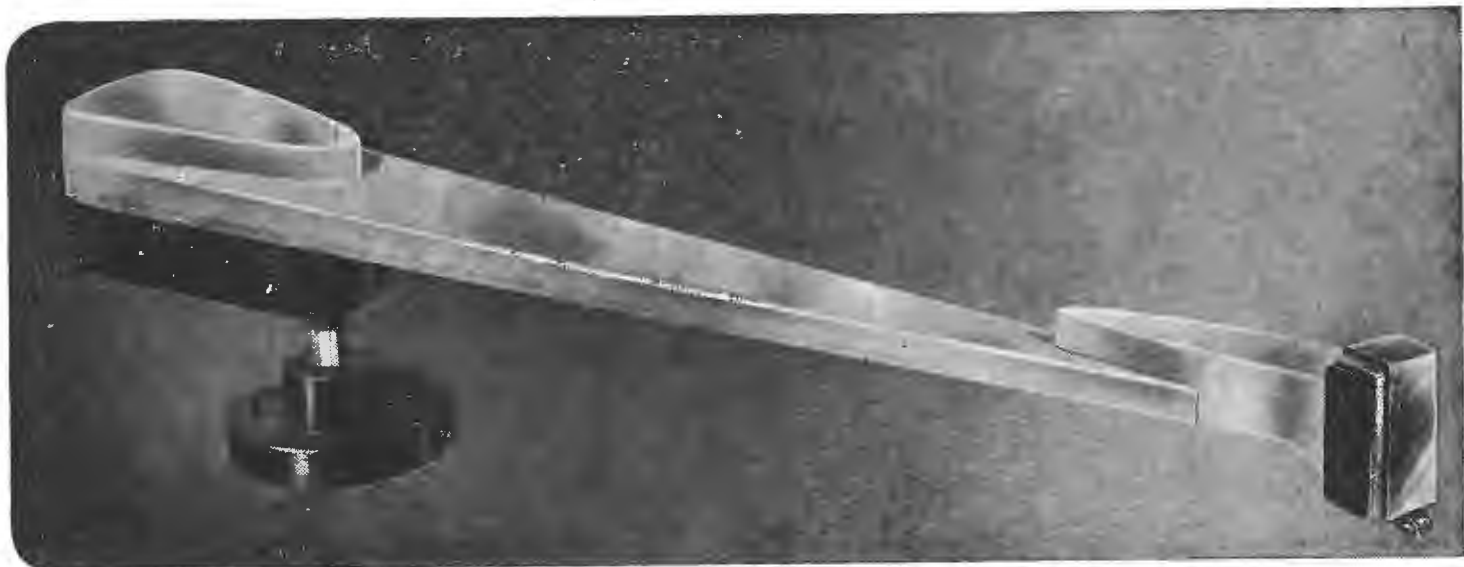

*And* TWO NEW  
'QUALITY' MICROPHONES

**MIC 22** Incorporates a sintercel insert which is more sensitive than sound-cell type: substantially flat response from 40 to 6,000 c.p.s.

**MIC 16** Incorporates the well-known floating sound-cell construction. Flat response from 30 to 10,000 c.p.s.



### The GP. 20 MICROCELL PICK-UP

The GP. 20 crystal pick-up establishes new standards in pick-up design. With provision for interchangeable pick-up head for "long-playing" records it has the following unique advantages;

- ★ 20 times greater output than comparable magnetic types.
- ★ Automatic bass-boost — can be fitted to any domestic radio without additional equalisers.
- ★ Needle talk and motor rumble negligible.
- ★ Record wear virtually eliminated.
- ★ Unbreakable and non-hygroscopic crystal element.
- ★ Permanent sapphire stylus eliminates needle-change.

PRICE £2 · 10 · 0 plus 21/5d. P.T.

★ SEE THEM AT RADIOLYMPIA · STAND 7 · DEMONSTRATION ROOM D.10

*Other acos products:* GP. 10 Crystal pick-up — a general purpose model with patented unbreakable crystal assembly. GP. 12 High Fidelity model pick-up with permanent sapphire stylus and excellent performance. GP. 7 Magnetic pick-up head for soundbox replacement. GP. 6 Magnetic pick-up, good performance with robust construction. RH. 1 Disc cutter-head — good performance and modest price for the amateur. RH. 2 High quality cutter-head which requires no equaliser circuit.

COSMOCORD · LIMITED · ENFIELD · MIDDX.

# AIR RADIO

## New V.H.F. Equipment Shown at Farnborough

**T**HE exhibition of aircraft equipment, which accompanies the flying display held by the Society of British Aircraft Constructors at Farnborough, Hants, revealed an interestingly new development in the field of v.h.f. radio equipment for use in aircraft. Hitherto most makers have provided a number of alternative channels in the one set with some simple form



Control Unit of Murphy 140-channel v.h.f. transmitter-receiver. In each case one knob selects the whole number and another the decimal part of the operating frequency.

of selecting switch. In recent years the tendency has been for more and more channels to be made available, but this year some makers have decided to anticipate future requirements and provide the maximum number possible in the allotted band of 118 to 132Mc/s.

At present the channel separation is fixed at 200Kc/s, which allows for 70 channels and equipment giving this number was shown by Standard Telephones. The send and receive frequencies are crystal controlled on all channels, but individual crystals are not used; indeed, it would be uneconomical so to do and the circuit is so arranged that 24 crystals are made to provide all the necessary frequency pegging.

On the control box, which contains the crystals, are two switches, one marked in whole numbers of Mc/s from 118 to 131 and the other in decimal fractions of 0.1, 0.3, etc., up to 0.9Mc/s. Selection of the operating channel is then made by setting the switches to the frequency required, for example, 120.1, 124.5 and so on.

To facilitate channel selection and avoid the need for retuning circuits, wide-band inter-stage couplings are usually employed. The Standard 70-channel set uses two wide-band transmitter units to cover the 14-Mc/s band, the remote control unit selecting the appropriate transmitter. One receiver unit only is used.

Murphy were showing a multi-channel v.h.f. set also, but in this case they have anticipated future needs to the extent of providing 140 channels with 100-Kc/s separation. Crystal control of both the send and receive frequencies is adopted and here again comparatively few crystals suffice for all purposes.

Channel selection is made on the basis of the frequency required, two switches being employed for the transmitter and two for the receiver. One selects the whole number of the frequency between



Plessey PTR61 lightweight aircraft v.h.f. equipment providing six crystal-controlled channels.

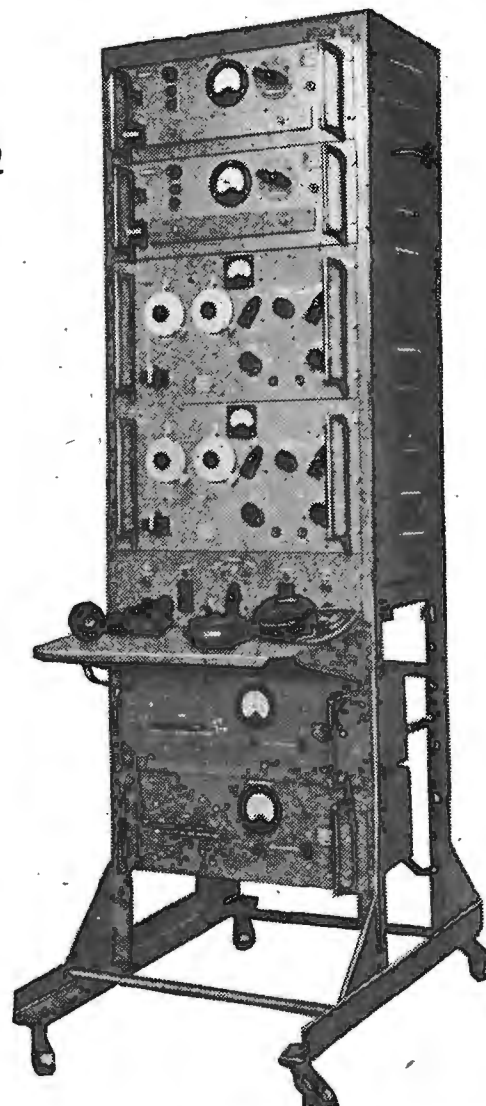

Ekco airport installation consisting of two transmitters, two receivers, power supplies and remote control panel.

118 and 131Mc/s, while the other selects the decimal fraction.

The transmitter circuits are, in this case, divided into 7 bands of 2Mc/s each, while the receiver has 5 bands of 3Mc/s and the switching automatically selects the required crystals and, by remote control, the appropriate transmitter and receiver bands.

A v.h.f. transmitter-receiver covering a considerably wider frequency range was shown by Ekco. It has been developed for the Ministry of Supply and is capable of providing, by remote control alone, some 312 channels spaced 180Kc/s apart in the band 100 to 156Mc/s or 281 channels with 200Kc/s spacing. The equipment is divided into five units comprising aerial unit, transmitter-receiver, main controller and power-modulator respectively. In addition Ekco had some lightweight v.h.f. equipments pro-

**Air Radio—**

viding up to 21 channels by the movement of a single switch.

There was a new v.h.f. aircraft set shown by Plessey known as the PTR61 and which has been designed for use where small size and low weight are of first importance, with simplicity of operation a close second. Six spot frequencies, all crystal controlled, in the band 116 to 132Mc/s are provided, but as crystals can be changed easily in the air many more channels are potentially available. A single control suffices to tune simultaneously both the transmitter and the receiver. The set gives intercom facilities for three positions in the aircraft.

For airport use Plessey were showing a single-channel crystal

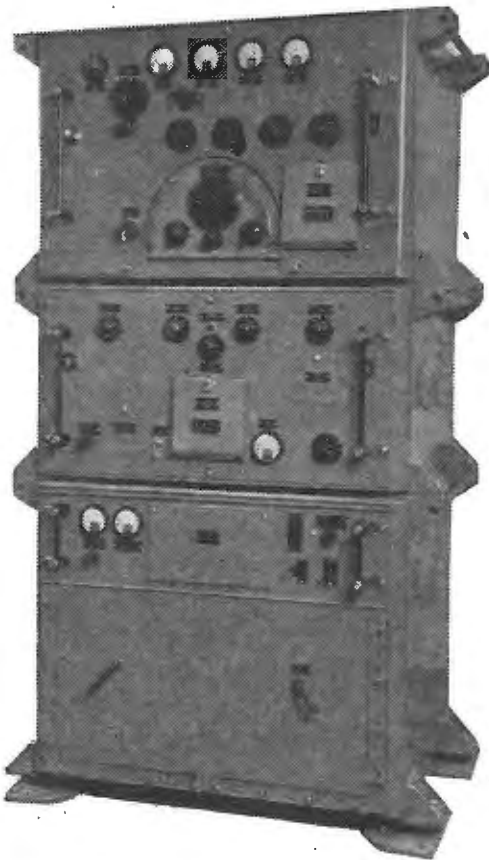

Redifon 300-watt airport transmitter designed for ease of transport.

controlled receiver covering 116 to 132Mc/s, while another set of a somewhat similar kind was seen on the Ekco stand. These sets are primarily for rack mounting with separate receivers permanently set up on the various frequencies used by the airport where they are installed.

Other v.h.f. equipment seen this year was a twin-channel transmitter and receiver in rack

form for airports made by Ekco, a 50-watt twin-channel transmitter, with both transmitters taking the same modulation, shown by Standard and a 100-watt twin transmitter working on spot frequencies in two bands, one being 116 to 132Mc/s and the other 2.5 to 13Mc/s. The last mentioned is a Plessey product known as the PT16.

Whilst the predominating interest was in the new v.h.f. equipment the other aspects of aircraft communications and radio navigation were not entirely forgotten. For example, Cossor Radar had an improved GEE ground station and a new miniature GEE receiver designed especially for small aircraft and very simple to operate. All the information needed to fly along a GEE lattice line is given by a visual "left-right" pointer indicator.

Also for air navigation Ferranti showed a prototype version of a new Consol and Radio Range Receiver, combining also facilities for r.t. reception in the band 225 to 510Kc/s. It is a miniature set measuring  $4 \times 8 \times 5\frac{1}{4}$  in only.

Another aid to air navigation was the Cloud and Collision Warning Radar operating in the centimetre band made by Ekco. Clouds up to 40 miles away are clearly visible on the display unit.

High-power ground transmitters for point-to-point communication for use as aircraft beacons and for long-distance communication with aircraft in the medium and high frequency bands, were shown this year. Redifon had a 300-watt transmitter which, while extremely robust, can readily be separated into three self-contained units each under 20lb in weight. This should help to solve some of the difficulties often met with when moving heavy equipment to remote airfields.

An output of 300 watts is also given by the new Cossor Radar airport transmitter which is capable of operation over the band 1.5 to 20 Mc/s using either telephony or c.w. or m.c.w. telegraphy.

A new communications receiver for ground use was shown by Redifon in the form of a junior version of the R50 set. Housed in the same cabinet and having most of the distinctive features

of this set, it differs primarily in the frequency coverage provided. In the R50A, as it is called, the coverage is from 585Kc/s to 32Mc/s in five ranges and one i.f. amplifier only is needed, which in this case is 465Kc/s.

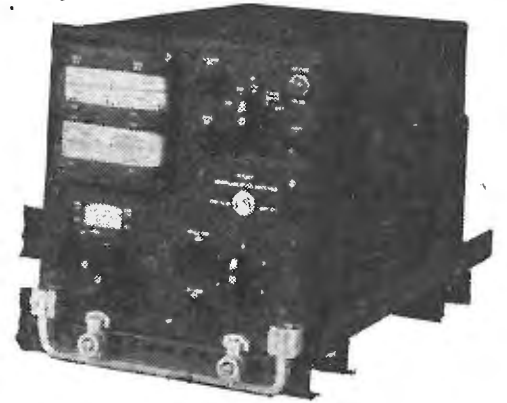

Marconi AD94 lightweight aircraft communication receiver.

Another recently introduced communications set, designed for use in aircraft, is the Marconi AD94 which is described as a high discrimination set in view of the small increments of calibration actually appearing on the extremely long moving tape scales. Calibrations are made at intervals of 10Kc/s, but much closer reading, and setting, than this is possible. It covers 2 to 18.5Mc/s and 150 to 510Kc/s.

For medium and high frequency operation in aircraft Marconi was showing, among other apparatus, a new high-power transmitter, the AD107 giving between 100 and 150 watts output on ten spot frequencies in the band 2 to 18.5Mc/s and 10 to 120 watts from 320 to 250Kc/s. A 140-watt 12-channel aircraft transmitter for a similar service was included in the Standard range of aircraft sets. The frequency range is 2.8 to 18Mc/s.

#### " WIRELESS WORLD " DIARY

ALL available copies of the *Wireless World* Diary for 1950 are being distributed by 12th October to newsagents and booksellers. The new edition of this useful pocket-sized book contains an 80-page reference section of technical data and general information which has again been revised. New and more convenient valve base tables show the connections of over 600 valves, and v.h.f. aerial data for the projected new B.B.C. services are given. The price of the Diary is 3s 4½d, including purchase tax.

# MAINS-BATTERY TURNTABLE

## A Simple Circuit

### Suitable for Public Address Work

By I. C. HUTCHESON, M.A.

THE public address operator finds, in general, a wide variety of apparatus from which he may choose to suit his needs. If, however, he wishes to reproduce gramophone records through a mobile public address system, such as a loudspeaker van, he is forced either to purchase a turntable which will operate directly from a battery supply, or to use one with a clockwork motor which requires frequent rewinding.

The ordinary a.c. mains induction turntable forms a part of the equipment of most public address engineers, and it can quite simply be operated by means of a special vibrator pack from a 12-volt car battery. This device has several

motor to the vibrator, into one which is resistive or capacitive.

It is well known that the breaking of a current in an inductive circuit causes high e.m.f.s to be set up, and in this case if C is omitted heavy sparking occurs at the vibrator contacts. If C is inserted,

pedance of the motor and C in series is greater, the motor torque is less. Thus a value of C must be struck which eliminates sparking, while not unduly reducing the torque.

A preliminary estimate of the approximate value of C can be made by assuming a vibrator frequency of 100 c/s and calculating a value of C which will have the same reactance as the inductive reactance of the motor. The latter can be calculated (if we ignore such things as change of phase angle with load) from a knowledge of the power consumed, the supply voltage and the d.c. resistance of the windings. In a particular case, the calculated value turned out to be  $0.34 \mu\text{F}$ , and in practice a value of  $0.25 \mu\text{F}$  was found to be satisfactory.

The current taken by the vibrator pack from a 12-volt battery is a little under 3 amps. This vibrator pack has had many hours of use and continues to function very satisfactorily. Similar methods could, no doubt, be employed for the running of other small mains motors from a low-voltage d.c. source.

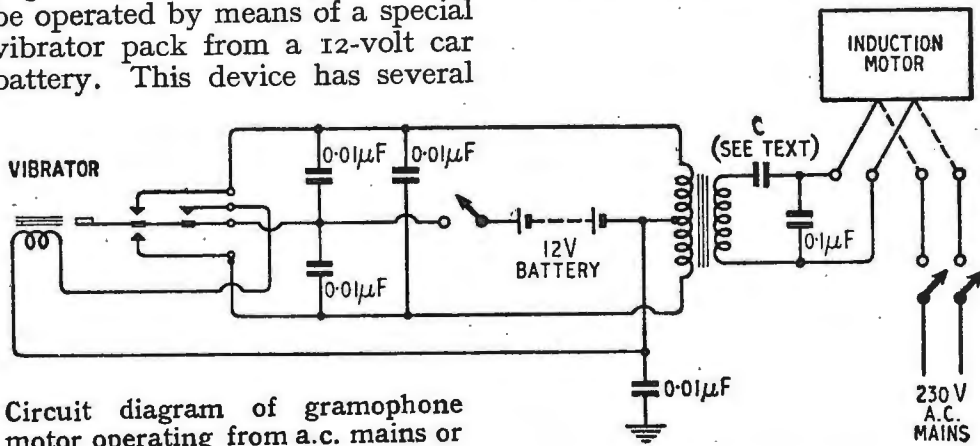

Circuit diagram of gramophone motor operating from a.c. mains or car accumulator.

advantages over the use of a rotary converter. The initial cost is lower, there is a moderate saving in size and weight, the noise is very much less and there is considerable reduction in current consumption.

The apparatus consists of a non-synchronous vibrator, a vibrator transformer with a centre-tapped primary and a number of small condensers. All these can be comfortably accommodated under the motor board of the normal turntable with the exception of the vibrator, which may be arranged to plug in through the board and thus be readily changeable.

The circuit, which is given above, is basically the same as that of a normal power pack giving an unsmoothed output of 230 volts a.c. at the vibrator frequency of about 100 c/s. There is, however, an important modification which consists of the condenser C in series with the motor winding. This has the effect of turning the inductive load, presented by the

however, and a suitable value discovered by trial and error, the sparking can be reduced to negligible proportions. Under these conditions the vibrator remains cool and does not burn out. With values of C below that giving resistive conditions, there is no further alteration in the amount of sparking, and, as the total im-

## PROXIMITY METER

THIS instrument, illustrated here, has many industrial applications for the control of thickness and composition in non-conducting films, the setting up of machine tools, etc. It functions on the measurement of minute changes of capacitance and has a sensitivity of  $0.01 \mu\text{F}$ .

The manufacturers of the meter are Fielden (Electronics), Holt-Town Works, Manchester, 10.

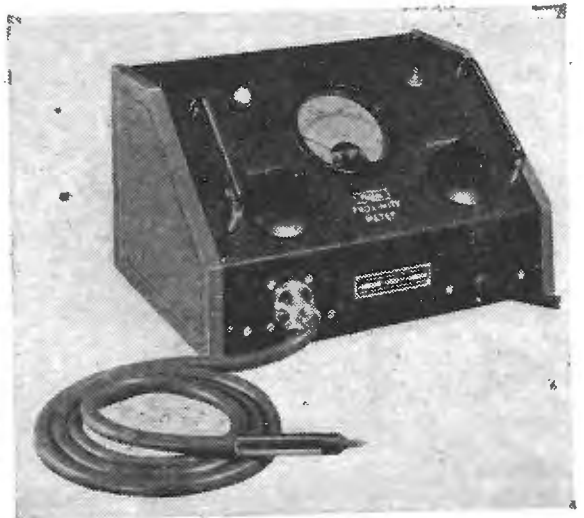

# NATIONAL RADIO EXHIBITION, 1949

OLYMPIA, LONDON. Wednesday, 28 SEPTEMBER, to Saturday, 8 OCTOBER  
 (Open daily, except Sunday, 11 a.m.—10 p.m. Admission 2/6)

## Alphabetical List of Exhibitors and Guide to the Stands

Name	Stand	Name	Stand	Name	Stand	Name	Stand
A.W.F.	203	D.S.I.R.	52	K.B.	65	" Practical Wireless "	100
Ace	21	" Daily Mail "	220, 221	Keith Prowse	104	Pye	72, 180
Acos (Cosmocord)	7	Dallas	T8	Kerry's	T1	Qualrad	202
Acrylite (Motor and Air)	91	Decca	41	Kleergaze (Levene)	158	R.A.F. (Air Ministry)	74
Admiralty	73	Defiant (Co-op W. Soc.)	28	L.E.S.	T17	R.C.E.E.A.	152
Advance	209	Dibben	T20	L. & P. Factors	T11	R.E.M.E. (War Office)	53
Aerialite	62	Dubilier	82	Lectrona (Acoustic Products)	208	R.G.D.	37
Airmec	156	Dynatron	2	Lee	157	R.W.F.	T9
Alba (Balcombe)	44	E.I.B.A.	T16A	Lloyds Bank	162	Radiomobile	42
Albion	T10	E.M.I.	67	Long & Hambly	14	Regentone	59
Ambassador (Fitton)	80	E.R.I.C.	181	Lowther	165	Roberts	96
Amplion	20	Econasign	169	Lugton	T7	Rola (Brit. Rola)	87A
Antiference	64	Eddystone (Stratton)	182	M.S.S.	76	Romac	88
Armstrong	92	Ediswan	47	McMichael	70	Rota-Time	103
Auratone	T16	Eelex (Eastick)	T3	Magnavista (Metro-Pex)	10	Royal Signals (War Office)	32
Avo (Automatic Coil Winder)	85	Ekco (E. K. Cole)	58, 153	Marconi	174	Scott	201
B.B.C.	151	" Electrical & Radio Trading "	T14	Marconi Inst.	154	Scott Wire	8
B.R.E.M.A.	211	Electron (New London)	98	Marconiphone	48	Servisol	216
B.R.V.M.A.	214	" Electronic Engineering "	155	Martins Bank	159	Shannons & Bishop	T19
B.S.R.	81	Erie	86	Masteradio	41	Simon	213
B.T.H.	178	Etronic (Hale)	68	Metrovick	179	Sobell	23, 24
Bafflette (Allan Radio)	49	" European Radio Programme "	94	Midland Bank	161	Standard	173
Baird (Scophony)	27	Ever Ready	46	Min. of Civil Aviation	33	T.C.C.	75
Barclays Bank	166	Ferguson	40	Min. of Supply	54	Taylor	16
Beethoven	11	Ferranti	43	Mullard	36, 176, 210	Telcon (T.C.M.C.)	30
Belclere (Bell & Croyden)	3	Franklin	204	Multicore	83, 84	" Television Weekly "	168
Belling-Lee	25	G.E.C.	38, 175	Murphy	56, 160	Trix	101
Bernards	217	G.P.O.	301	National Prov. Bank	163	Truvox	18
B.I. Callender's	55	Gamma	4	Nettlefolds (Guest-Keen)	185	Ultra	78
Board of Trade	51	Garrard	79	Norman (Rose)	T6	Vidor	69
Brimar (Standard)	60	General Sonic	74A	Oldham	218	Vitavox	12
Brit. Moulded Plastics	22	Goldring (Scharf)	97	Ossicaide (V. A. Foot)	170	W.B. (Whiteley)	77
British Railways	171	Goodmans	6	Peerless	15	Wearite (Wright & Weaire)	63
Brown Bros.	T12	Grampian	90	Petter	T18	Webber	T2
Bulgin	1	H.M.V. (Gramophone Co.)	57	Philco	39	Westinghouse	177
Burndept	172	Haynes	9	Philips	34	Westminster Bank	167
Bush	66	Hazlehurst	205	" Pianomaker, Music Seller & Radio Retailer "	T13	Weston (Sangamo)	219
Celestion	87	Hobday	T15	Pilot	45	Wharfedale	215
Champion	26	Houghton & Osborne	93	Plus-a-Gram (Margolin)	102	Winter Trading	T5
Chloride	19	Hunt	17	Polar (Wingrove & Rogers)	212	" Wireless & Electrical Trader "	T4
Collaro	61	Imhof	89, 183	Portogram	99	" Wireless World "	29
Concordia	5	Invicta	71			Wolsey	13
Connoisseur (Sugden)	207	Judge	206				
Coösor	35						

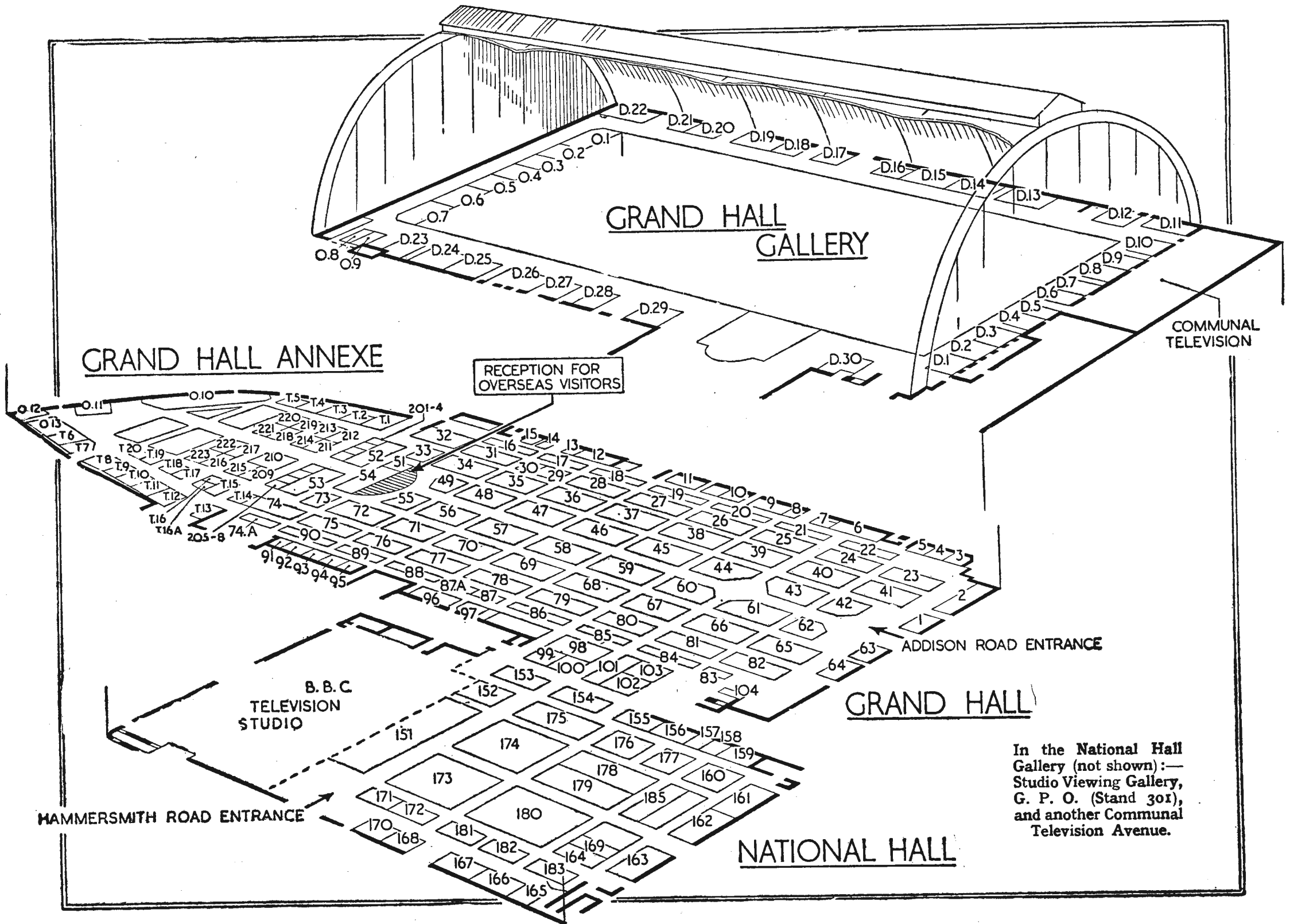

In the National Hall Gallery (not shown):—  
 Studio Viewing Gallery,  
 G. P. O. (Stand 301),  
 and another Communal  
 Television Avenue.

# CLASSIFIED

## Principal Classes of Exhibits at a Glance

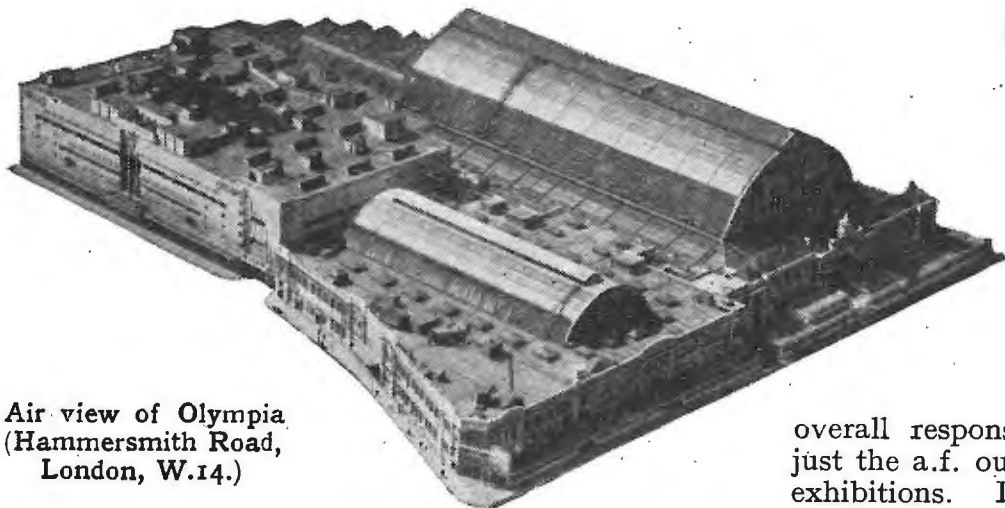

Air view of Olympia  
(Hammersmith Road,  
London, W.14.)

**I**N preparing our "Guide to the Show" we have this year adopted a different method of presentation in the belief that it gives a more comprehensive view of the present activities of the firms represented, both for the visitor to the show and those who will have to depend on the pages of *Wireless World*. All the main products of the radio industry are classified under convenient headings, and the exhibitors of any particular product, with their stand numbers, can be found in a moment. These tables, which are on pp 379-382, are as complete as they can be up to the time of going to press.

It is not easy to pick outstanding features from the mass of information obtained from manufacturers, but it would appear that the return of the television-broadcast-radiogramophone set is the feature of Radiolympia, 1949, which, organized by the Radio Industry Council, is the sixteenth in the series. There will, of course, be the usual "surprise" items, details of which have been kept closely guarded by manufacturers until the show opened.

### Television and Sound Distribution

Television is the *pièce de résistance*, and nearly 40 manufacturers are exhibiting sets. Special arrangements have been made to provide visitors with facilities for viewing both the transmitted scene and the received picture. The B.B.C. television studio in the National Hall, which is more than twice the size of the entire studio space at Alexandra Palace, is overlooked by a glass-enclosed gallery from which visitors can watch rehearsals and performances. The studio equipment includes three of the new C.P.S. Emitron cameras.

Additional floor space and improved arrangements for the viewing of a variety of receivers in the television communal demonstration avenues in the two galleries have been provided this year. In addition to these, a number of manufacturers have their own demonstration rooms where both sound and vision receivers are demonstrated. A list of these is given at the end of the numerical list of stand holders on p. 384.

As already announced, a radio-frequency distribution system is fed to the demonstration rooms. Long- and medium-wave transmissions picked up by an aerial erected on the roof of the hall are fed by r.f. to these rooms, thus enabling visitors to assess the

overall response of broadcast receivers instead of just the a.f. output as has been the case at previous exhibitions. In conjunction with this system, a specially recorded programme of speech and music is distributed on 767 kc/s (391.1 metres)—the frequency of the Scottish Home Service, which is not normally receivable at an entertainment value in London.

Our tabular guide to the show deals only with the commercial exhibits. There are, in addition, a number of stands occupied by non-commercial producers and users of radio and electronic equipment including the Ministries of Supply, Air and Civil Aviation, the D.S.I.R., G.P.O., Board of Trade and the Armed Forces. One section of the Post Office exhibit, which is located on a large site in the National Hall Gallery, is devoted to a display dealing with the suppression of electrical interference. An Interference Information Bureau is also provided. In another section a Post Office coast station is reproduced and visitors can see how distress calls from ships are dealt with. The part played by the Post Office in the extension of the television service to the Midlands—the provision of the radio and cable links—is also shown.

The cathode-ray direction-finding equipment for the location of thunderstorms, as used by the forecasting stations of the Meteorological Office at Dunstable, Camborne, Leuchars and Irvinestown, is being demonstrated by the Department of Scientific and Industrial Research. The D.S.I.R. is also showing the apparatus used by its Radio Research Station at Slough for ionospheric sounding.

Radio research and development work undertaken at the various establishments of the Ministry of Supply are featured on Stand 54. Among the equipment shown is a pulse code modulator designed to code and decode speech and automatic frequency-selecting mechanism for airborne transmitter-receivers.

Ground controlled Approach equipment (G.C.A.) is shown on the stand of the Ministry of Civil Aviation to demonstrate its use at London Airport. Visitors can watch the course of a model aircraft as it comes in to land and at the same time see the "blips" on the G.C.A. screen.

The War Office has two stands. One is devoted to a display showing the diversity of wireless equipment used by the Army. It includes the latest "walkie-talkie" (No. 88) receiver which is frequency modulated. This stand is staffed by Royal Signals. The maintenance of Army telecommunication and electronic control equipment is the responsibility of R.E.M.E., and members of the Corps are demon-







(Below) Pye Model D18T television console.

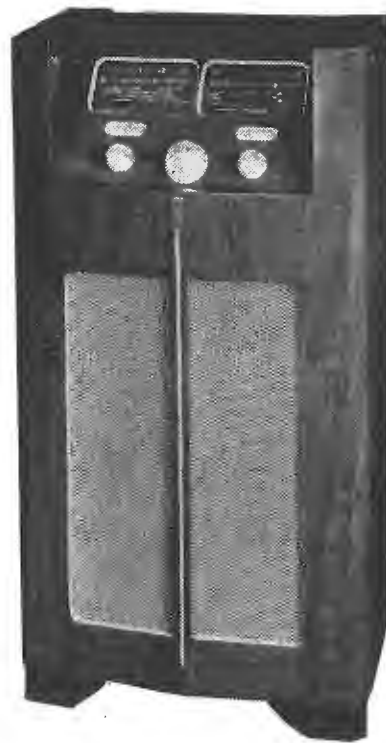

McMichael Model 492 console a.c. receiver.

Murphy baffle type receiver, Model A146C.



Bush DAC90 mains portable.

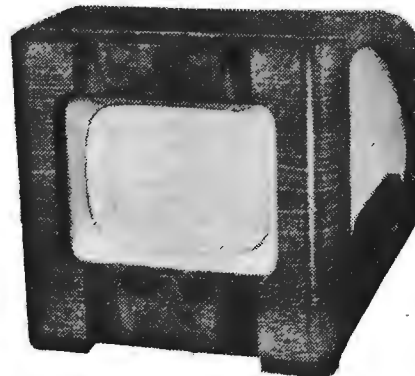

Baird "Everyman" television receiver.

H.M.V. 1851 television receiver with 15-in tube and all-wave set.



(Right) Philips Model 291U mains portable.



Invicta Model 55 portable ("Twin-victa").

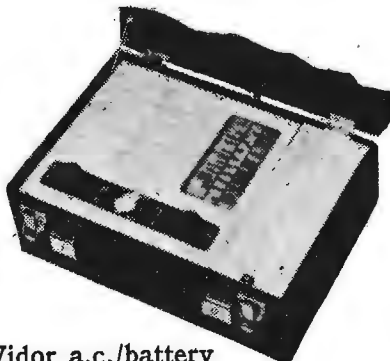

Vidor a.c./battery attaché portable.



Cossor 914 television set with 10-in tube and all-wave broadcast receiver.

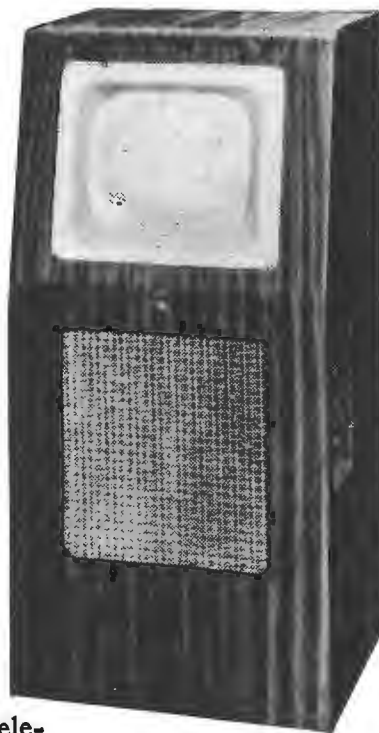

Ekco TSC93 television console.



(Below) : Wolsey television aerial with folded dipole.

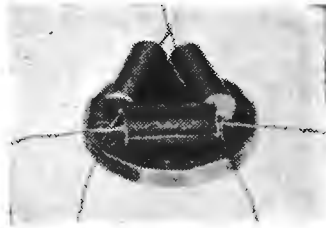
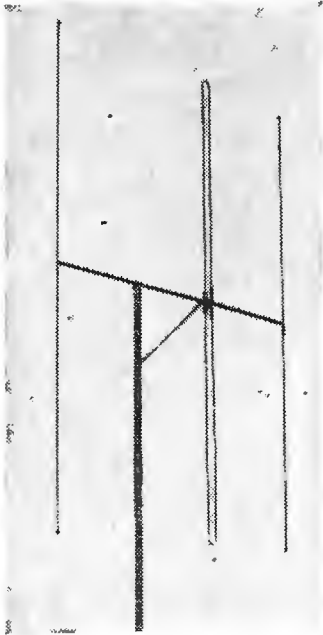

Hunt's moulded paper capacitors (up to 0.01µF) on a 3d piece.



Vitavox hand microphone.

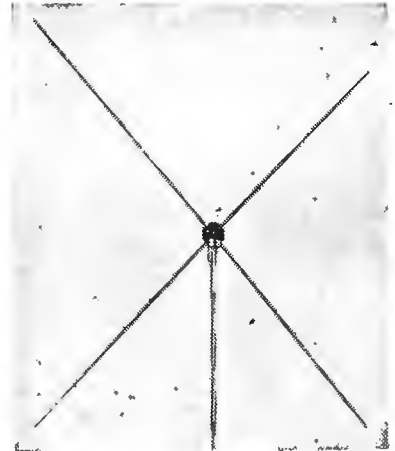

Antiference "X" television aerial.



New Dubilier Type Q volume control with switch.

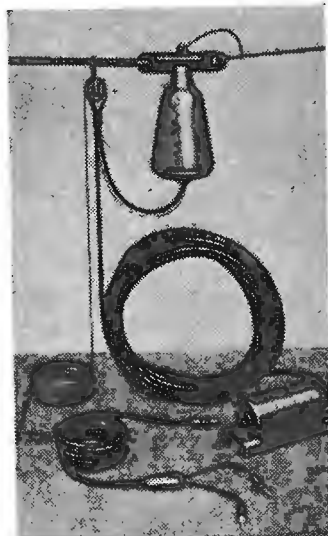

Belling-Lee anti-interference aerial kit.



(Left) Telcon 300-Ω transmission line Type K35.



(Right) Wharfedale "Super 12" loudspeaker.

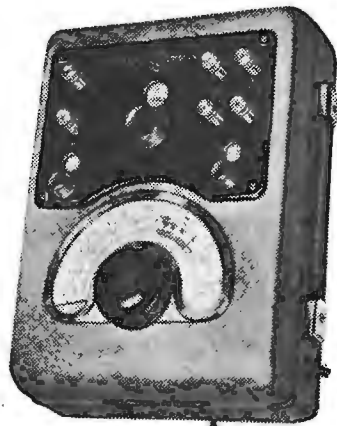

Avo electronic test unit.

Sangamo-Weston Model S75 portable test set.

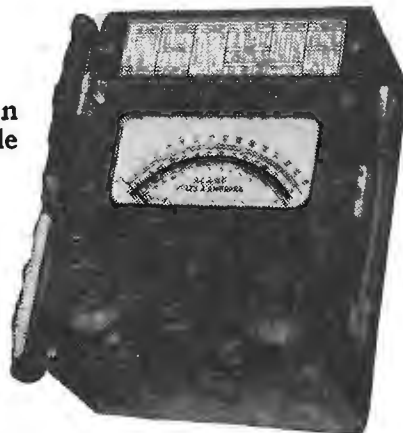

E.R.I.C. valve voltmeter with ranges up to 1,000V.



Erie diode filter unit.

Marconi Instruments high-velocity level recorder Type TF946.

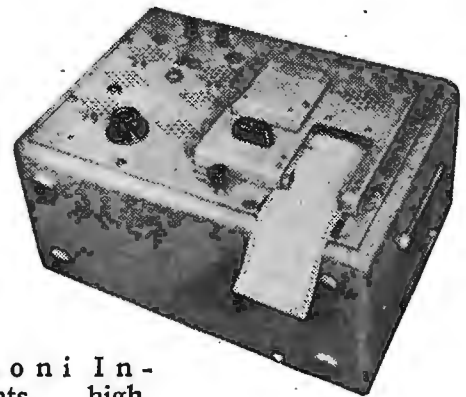

R.G.D. magnetic tape recorder.

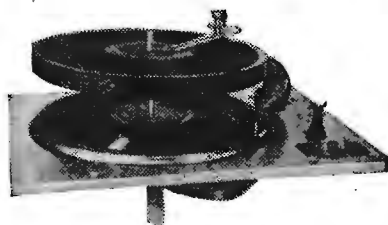
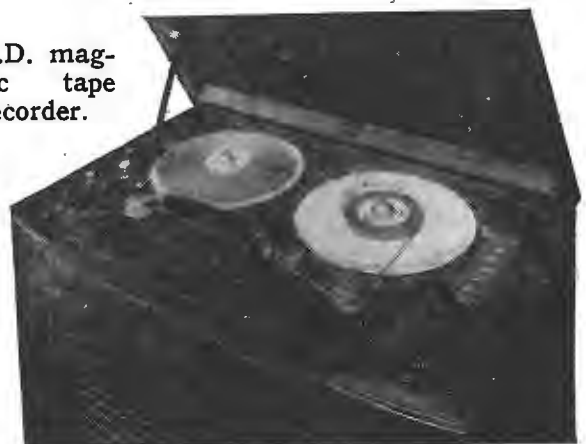

Collaro RC500 rim-drive automatic record-changer.



# THE "BELLING-LEE" PAGE

Providing technical information, service and advice in relation to our products and the suppression of electrical interference

## NEW AERIALS

By the time this page is being read, Radiolympia will be open and we sincerely hope to meet many of the readers of "The Belling-Lee Page" on our stand No. 25, where we will be showing our new range of aerials and many types making use of ingeniously engineered light alloy die castings for fixing brackets, etc. The light-weight range will be shown for the first time, symbolised

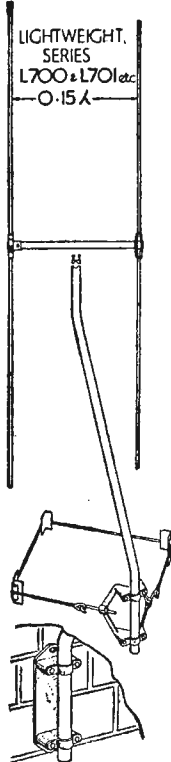

Fig. I

### The New "Twinrod" T.V. Aerial for windowsill mounting.

This new dual purpose aerial may be used either for the reception of broadcast or television programmes. As a broadcast aerial it will give better results than the "Winrod" and much better results than any indoor aerial.

When used for television, it is excellent and convenient, provided always that its use is confined to locations not greatly in excess of fifteen miles depending upon the absence of metal-framed buildings, etc., close to and between it and the television transmitter. In favourable conditions this distance would be greatly exceeded. It is a fully dimensioned half wave dipole and must not be confused with compressed dipoles and therefore should give by comparison a better picture.

The "Twinrod" might be described as the marriage of the "Winrod" and the "Doorod." It is the obvious development to use the now well-known and very

popular "Doorod" as an outdoor aerial suitable for mounting on a window sill or gutter board. The upper element is rigid and like the "Winrod" is designed to stand away from the building. The lower element is a flat flexible which, for best results, should be allowed to hang straight down, being stapled to the wall to prevent swaying in the wind, which would cause picture flutter and would soon impair the insulator. For absolute optimum results this flexible element should be "stood off" the wall by a few inches, but this is by no means essential. Where it is not practicable or desirable to let the flexible element hang straight down, it may be bent over, to run under the window ledge, but if at right-angles from the rigid element, there will be an appreciable loss in signal, but even then there should be adequate pick-up if the location is normal, and the distance not greater than 5-8 miles from the transmitter.

At the centre insulator there will be found a metal strap. The position of this decides whether or not the aerial is adjusted for television or broadcast reception. It cannot normally be used for both at one time. Each "Twinrod" is supplied with eighteen feet of coaxial feeder which is sufficient for most normal rooms. This may be lengthened within reason.

### The "Viewflex" Indoor T.V. Aerial.

This is revolutionary in design, but technically it is as efficient as a "Doorod," or in fact any other type of indoor television aerial. It may not be found so convenient to fix as the "Doorod," but it will only require the household steps so as to make the full use of height. In the "Viewflex" both elements of the dipole are flat flexible conductors with polythene insulation. It should be fixed with as much of it as possible, vertical. Where the height of the room is such, that it cannot all be vertical then the lower element may be bent at right angles without too much loss in signal.

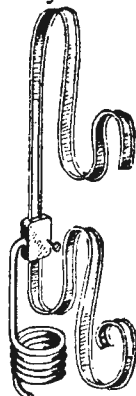

Fig. III

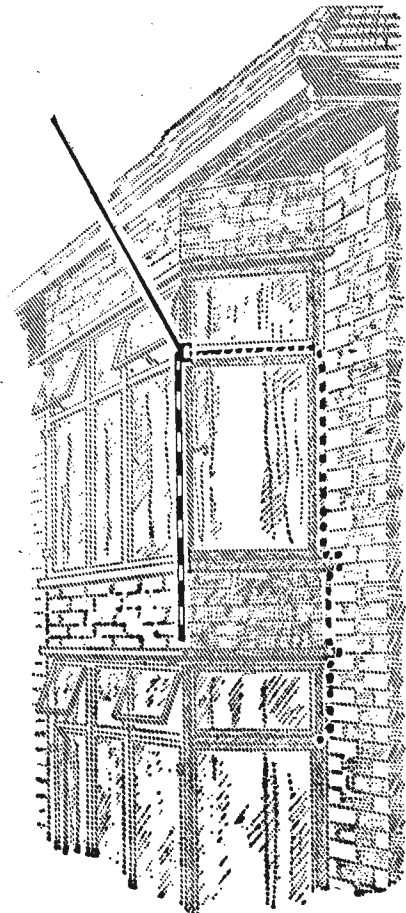

Fig. II

### Mobile Research Unit.

Readers of this page will be interested to know that our Mobile Research Unit will be sited at Radiolympia and will be open for visitors inspection.

- \*1. "Viewrod" light-weight series (Registered patents applied for) 'H' type 0.15 wave spacing 3/8 in. dia. elements
  - L.700 London } with suffixes
  - L.701 Midland } below
  - /C for own mast 45/-.
  - /W mast wall fixing 70/-.
  - /L mast, 1 lashing, 84/-.
- \*2. "Twinrod" window mounting (Registration & patents applied for)
  - L.694 London } with suffixes
  - L.695 Midland } below
  - /1 with coaxial feeder, 32/6.
  - /2 with balanced feeder, 29/-.
- \*3. "Viewflex" indoor T.V. aerial (Registration & patents applied for)
  - L.696 London } with suffixes
  - L.697 Midland } below
  - /1 with coaxial feeder, 21/-.
  - /2 with balanced feeder, 17/6.

Lightweight dipoles from 25/-.

Indoor T.V. Aerials from 17/6.

Senior range T.V. aerials from 57/6.

Multi element arrays. 210/-

**BELLING & LEE LTD**  
CAMBRIDGE ARTERIAL RD., ENFIELD, MIDDX., ENGLAND



MEET US AT  
**RADIOLYMPIA**  
 SEPT 28 - OCT 8  
**STAND No. 77**

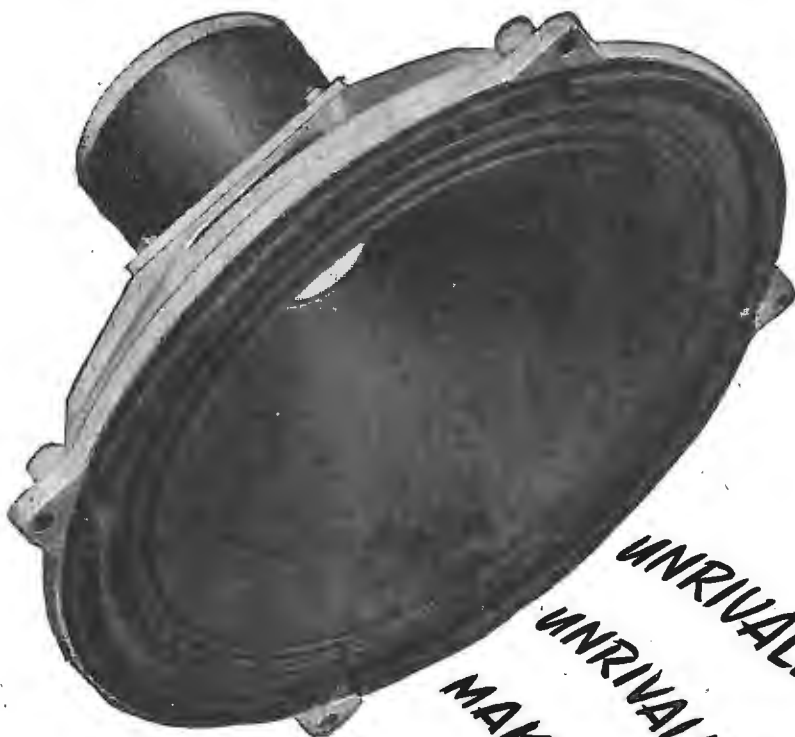

12 in. chassis.  
 Flux density 13,500 gauss.  
 Pole diameter 1½"  
 Gap .050"  
 Handling capacity 15 watts.  
 Price: £7.7.0. with transformer

*UNRIVALLED TECHNICAL FACILITIES,  
 UNRIVALLED PRODUCTION RESOURCES,  
 MAKE POSSIBLE  
 THIS GREAT RANGE*

Every part of every W/B speaker—cone, magnet, speech coil assembly, cabinet—is made within the one organisation. The close correlation of design thus made possible is part of the reason for the typical performance. High fidelity large units, diffusers, industrial and relay speakers, extension speakers, each in their class give outstanding reproduction and unmatched reliability.



"Baffle" extension speakers for any set from 39/6

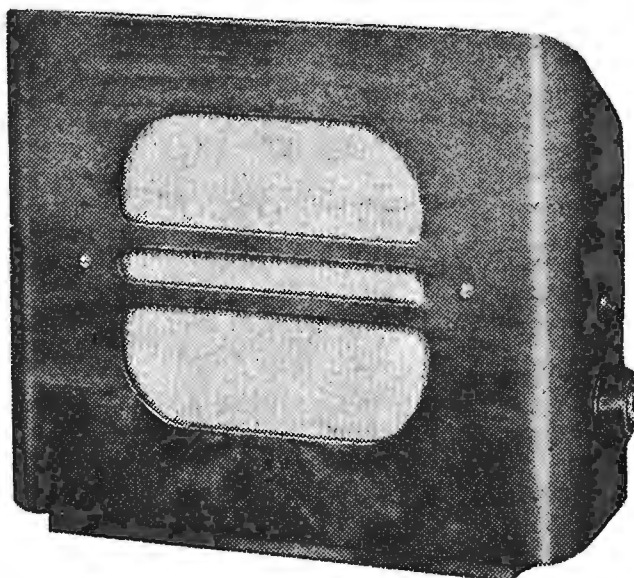

*Stentorian*

WHITELEY ELECTRICAL RADIO CO. LTD · MANSFIELD · NOTTS



## WORLD OF WIRELESS

### Television at Home and Abroad ♦ Cable and Wireless Changes

#### Anglo-French Television

FURTHER details of the recent meeting of the C.C.I.R. at which the question of European television standards was discussed, resulting in the French decision to adopt 405 lines, have been issued by the International Broadcasting Organization.

The Study Group of the C.C.I.R. responsible for investigating this vexed question of television standards met in Zurich in July. The countries represented were: Austria, Belgium, Czechoslovakia, Denmark, France, Italy, Netherlands, Sweden, Switzerland and the United Kingdom. It is noteworthy that in addition to these European administrations the United States was represented and among the manufacturing companies present was the R.C.A.

In order to facilitate the discussion of standardization, a questionnaire had been circulated to countries represented and replies were considered. The two bands under consideration were the 41 to 68 Mc/s and 174 to 216 Mc/s.

It was concluded that world standardization, although desirable, was not possible in these bands, but would be practicable in the 470 to 960-Mc/s band.

When considering what was regarded as the most suitable number of lines per frame, the French and U.K. delegations stated that they intended to unify their existing "medium" definition systems on 405 lines and proposed the establishment of a high definition system on 819 lines operating in the 174 to 216-Mc/s band. It was further stated by France and the U.K. that a change to 525 lines, recommended by America, or even 625, recommended by other European countries, would not be justifiable.

#### International Television

DELEGATES to the International Television Convention and Exhibition held in Milan in the middle of September had the opportunity of comparing British, French and American television gear.

Large-screen 625-line equipment, working on a closed circuit, was demonstrated jointly by Marconi's and Cinema Television. The screen used measured 16 x 12.5 feet. The French delegation demonstrated 819-line equipment and the Americans 525-line gear. The British 405-line standard was not shown.

L. H. Bedford of Marconi's was one of the British delegates and addressed the Convention.

#### U.N. Radio

IN preparation for the installation of communications equipment in the new United Nations headquarters, a firm of American consultants is compiling an analysis of available equipment, including British. Manufacturers are therefore asked to submit catalogues and descriptive matter of any of the following equipment: television gear, including cameras, amplifiers, control gear, monitors and tele-ciné equipment; and broadcast studio equipment, including control consoles, amplifiers, loudspeakers, microphones, turntables and disc, wire and tape recorders. Material should be sent to Dr. Walter Duschinsky, c/o Van Doren-Nowland & Schladermundt, 205, East 42nd St., New York, 17.

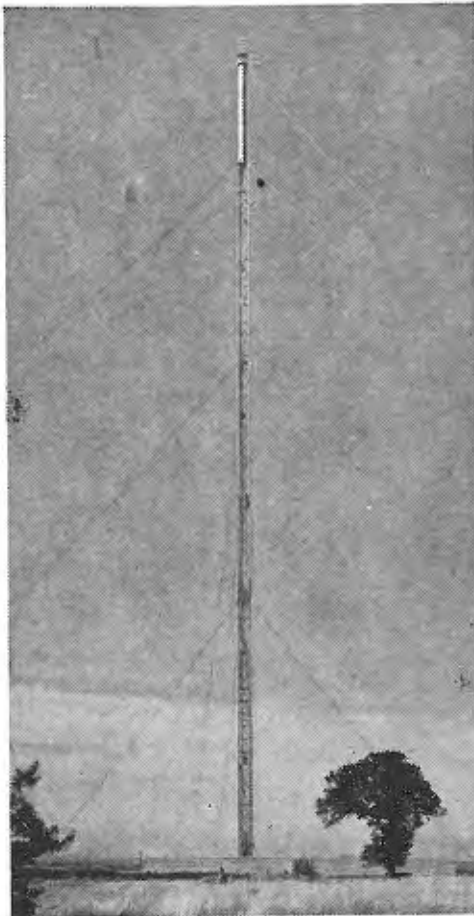

MIDLAND TELEVISION.—The completed mast of the Sutton Coldfield television station which has been installed by B.I. Callender's Cables. The topmost section, which is tubular, is slotted for F.M. transmissions.

#### Midland Television

COMPLAINTS have been made in the Midland area regarding the inability of television set owners to receive the signals from the B.B.C. pilot transmitter, which, as mentioned in August, are being radiated from Birmingham, Wolverhampton and Coventry.

It is stressed by the B.B.C. that the signals are intended to help the radio trade only so that dealers within the limited range of the pilot transmitter, using aerials specially aligned for the purpose, can tune in the transmissions and thereby test receivers and get used to adjusting them. Aerials erected for members of the public are, of course, orientated on the Sutton Coldfield transmitter, which is not yet operating. Some private viewers are receiving the signals because they are favourably situated in relation to the site of the temporary transmitter.

#### Commonwealth Telegraphs Act

SOME interesting details of the events leading up to the passing of this Act, which was recently given the Royal Assent, are outlined in the August issue of our contemporary, the *Post Office Telecommunications Journal*.

The two main effects of the Act are:—(a) the setting up of the Commonwealth Telecommunications Board and (b) the P.M.G. is empowered to take over all the assets and staff of Cable and Wireless Ltd. within the U.K. This transfer will take place on April 1st next year but C. & W. will continue as a U.K. limited liability company operating radio and cable telegraph networks in the colonies and in foreign countries. Of the companies staff of 5,000 in this country, about 90% will be absorbed by the Post Office; the remainder will be retained by the company at its headquarters.

#### Aircraft Radio

IN order to expedite the testing of and fault locating in aircraft radio apparatus at airports, an equipment tester simulating the conditions under which the sets are used in the aircraft has been designed and produced jointly by Marconi's Wireless Telegraph Company and Marconi Instruments. Described as the type OA216, it is a comprehensive collection of test ap-

### World of Wireless—

paratus incorporated in one steel cabinet measuring 4ft wide, 3ft high and 16in deep.

Although it has been specifically designed for testing the Marconi range of aircraft sets, intercom systems and radio compass, it is sufficiently flexible to enable any other make of apparatus to be dealt with expeditiously. The principal items in the assembly can be identified by the lettering on the accompanying illustration and the inscription below it.

### Two-Metre Transmitter

**A** CRYSTAL-controlled transmitter for use on the 145Mc/s band has been introduced by Labgear, Willow Place, Fair Street, Cambridge, for amateur use. The design is based on orthodox and well-tried practice, and it should give reliable and efficient service.

It is designed to take three 8Mc/s crystals and selection of the desired final frequency is effected by a panel switch. The crystal oscillator is an EF50 and this is followed by two frequency multipliers using QVO4-7 valves. The output stage is a push-pull 829B beam tetrode. Anode modulation is employed and sufficient a.f. gain is provided to permit the use of a crystal microphone.

### OBITUARY

It is with regret we record the death of **Captain A. G. D. West**, managing director of Cinema Television, as the result of a climbing accident in Switzerland on August 22nd. He joined the B.B.C. in 1923 at the age of 26 as asst. chief engineer. In 1929 he left the B.B.C. to become chief of design and development for the Gramophone Co. His first appointment in television came in 1933 when he became technical director of Baird Television (now Cinema Television). Captain West was a founder member of the International Television Committee and was this year appointed vice-president. He was to have taken a prominent part in the international television exhibition which opened in Milan on September 11th. He was president of the British Kinematograph Society from 1938 to 1946.

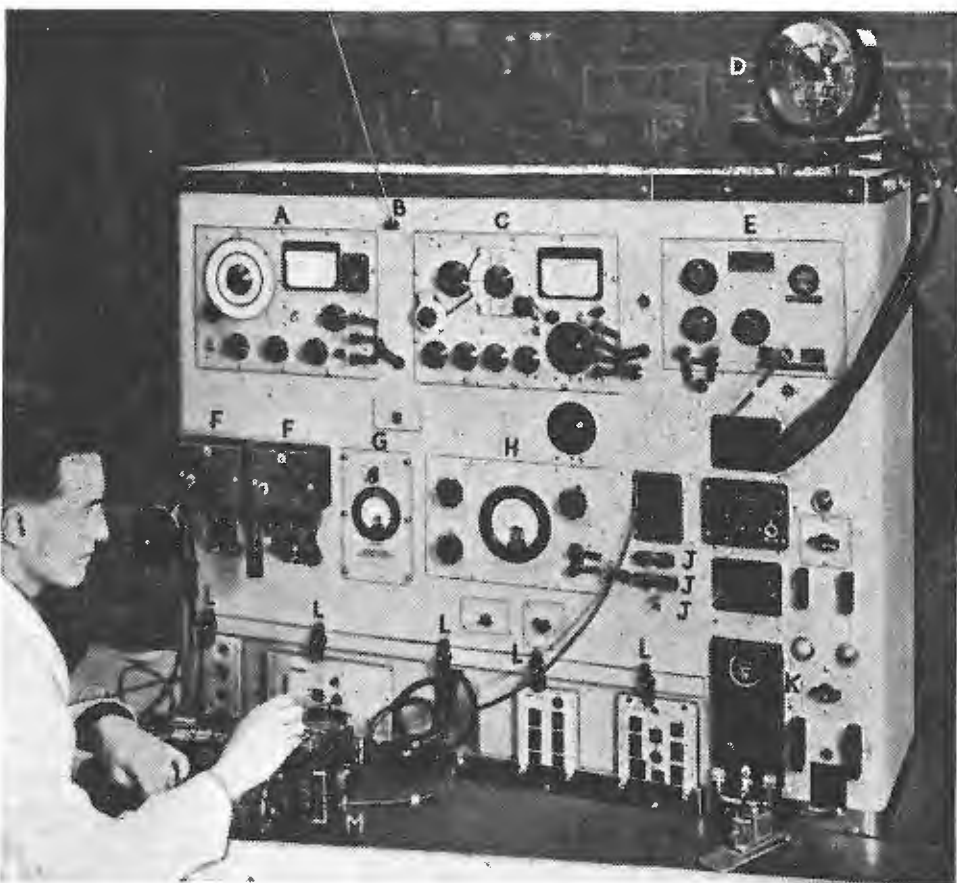

**TYPE OA216 Marconi aircraft radio tester.** The principal items are as follows:— **A**—beat frequency a.f. oscillator, **C**—signal generator, **D**—radio compass loop, **E**—direction finder test set, **G**—artificial aerial for transmitters, **H**—output meter, **J**—artificial aeriels for receivers, **K**—l.t. voltage regulator.

### PERSONALITIES

**Arthur L. Budlong**, who has been assistant secretary of the American Radio Relay League for twenty-three years, has been appointed secretary and general manager in succession to the late Kenneth B. Warner.

**G. Darnley-Smith**, who has been on the Board of Cinema Television for some time, has been appointed managing director in succession to the late Captain A. G. D. West. He is also managing director of the associated company, Bush Radio, and was chairman of the R.I.C. in 1946.

**Alan Knight** has joined Philips Electrical as car radio manager. Prior to entering the radio industry some seventeen years ago, he was in the export department of General Motors of New York. During the war he was in the Ministry of Production.

**H. J. Leak**, director of the company bearing his name, has gone to America to exhibit audio amplifiers at the Audio Fair which is being held in New York from October 27th to 29th. The show is sponsored by the Audio Engineering Society of America.

**J. T. Moore**, who has been with the Philips organization since 1928, has been appointed Midlands television executive by the company.

**Louis G. Pacent**, president and technical director of Pacent Engineering Corp., New York, has been appointed consulting engineer by Plessey International of Ilford.

**H. M. Thorne** has been appointed radio sales manager by Philips Electrical. He joined the company in 1929 and has been for some time personal assistant to H. Slater, director in charge of the radio and television side of the business.

### IN BRIEF

**Licences.**—With increases of 40,150 "sound" licences and 7,250 television licences during July, the total at the end of the month was 11,958,250. Of this total 155,150 were for television receivers.

**Radiolympia, 1951.**—It is announced by the Radio Industry Council that Olympia has been booked for a session in June each year from 1951 for the National Radio Exhibition. The relative merits of an early or late summer show have been discussed for some years; the disadvantages of the latter being that it follows too soon after the

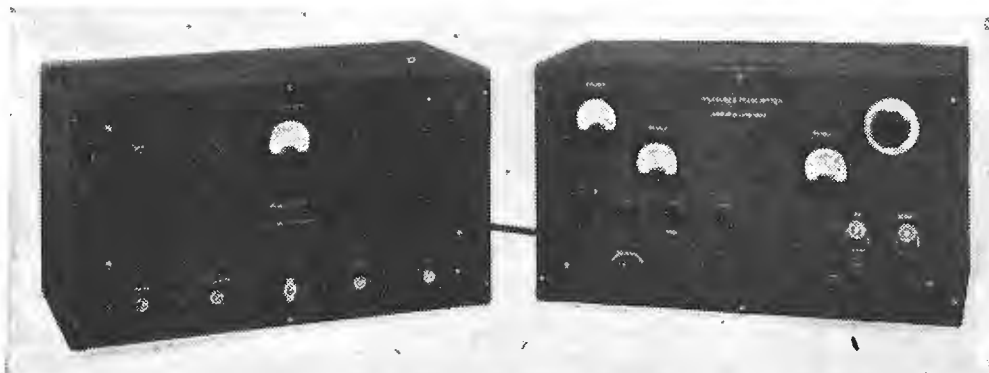

**AMATEUR'S SET.**—The two units comprising the Labgear 145 Mc/s amateur transmitter referred to above.

annual holiday period when most works are closed and, too, it interferes with autumn production plans.

**American Amateurs.**—New amateur regulations proposed by the American F.C.C. would, according to the A.R.R.L., amount to undesirably rigorous control of amateur transmitting activities. The A.R.R.L. has lodged with the Commission a lengthy statement by way of protest.

**Electronics.**—Among the courses of lectures arranged by the Dept. of Mathematics and Physics at the Polytechnic, Regent St., London, is a post-graduate course on electronics which will be held on Thursdays from 7.0 to 8.30, commencing September 29th. The first part of the course will deal with emission of electrons from solids, the second with amplifiers and oscillators and the third with ultra-high frequency techniques. The fee for Parts A or B is 12s 6d and for C 25s.

**Overseas Standards.**—The British Standards Institution asks us to remind manufacturers that the institution acts as the agent in this country of all overseas national standards organizations and, as such, is in a position to supply copies of Standards issued by them.

**Amateurs' Examination.**—The Dept. of Technology of the City and Guilds of London Institute announces that 636 of the 898 candidates passed the Radio Amateurs' Examination in May preparatory to receiving a transmitting licence. In the report of the examiners it is stated that the only question which appeared to give serious trouble was that dealing with the calculation of circuit values.

**Evening Courses.**—Among the courses arranged by the South-East London Technical College, Lewisham Way, S.E.4, is one of thirty lectures on r.f. and electronic measurements. It commences on October 14th at 7.0; fee £1. Another course of about thirty lectures, which commences on October 17th at 7.0 deals with the theory and design of communication networks.

**Broadcasting Stations.**—The fifth edition of the 88-page *Wireless World* booklet "Guide to Broadcasting Stations" is now available, price 1s 6d from booksellers and newsagents. In addition to the lists giving operating details of over 350 long- and medium-wave European stations and of some 1,300 short-wave stations of the world, it includes the European frequencies allocated under the Copenhagen Plan which is due to come into force next March.

**DESIGNED FOR COUNTING**  
and batching small articles at high speed, the type ECB144 electronic counter made by Sargrove Electronics, Effingham, Surrey, will operate in units, tens, dozens or grosses, giving visual indication of the process, and automatically repeating at the end of the chosen cycle. Maximum counting speed is 20,000 per second.

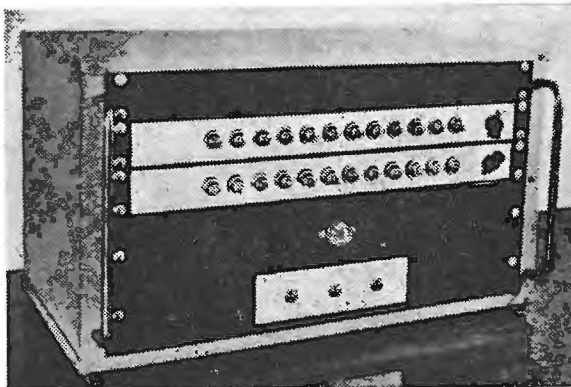

**"Wireless World" at Radiolympia.**—A range of new technical books, including some new editions and reprints, will be on view at our stand (No. 29, Grand Hall).

**Sound Reproducing Equipment** consisting of two 300-watt amplifiers feeding 360 loudspeakers has been installed by the G.E.C. in the Central Office of the Ministry of National Insurance at Benton, Newcastle-on-Tyne, where 7,500 are employed.

**Magnetic Recording.**—The latest of the series of booklets to be issued by E.M.I. containing papers read by members of the staff to learned societies is entitled "Some Fundamentals of Magnetic Recording" by E. W. Berth-Jones, B.Sc. of E.M.I. Studios. It is based on a lecture given by the author to members of the British Sound Recording Association. The booklet, priced 2s 6d, is available from the Advertising Division, E.M.I. Sales and Service, Hayes, Middx.

**Radio Servicing.**—Of the 153 candidates who sat for the Radio Servicing Certificate examination in May, 89 passed both the written and practical sections and 24 passed the written examination only. The exam is organized jointly by the Radio Trades Examination Board and City & Guilds.

**Components Exhibition.**—The seventh annual exhibition of radio components, valves and test gear organized by the Radio and Electronic Component Manufacturers' Federation, will be held at Grosvenor House, Park Lane, London, W.1, from April 17th to 19th next year.

**Reunion.**—We have been asked to announce that a reunion of those who worked in the Test Dept., No. 1 Signals Depot, R.A.F., West Drayton, will be held at Paxtons Head, 153 Knightsbridge, London, S.W.1, on October 8th at 7. Further information is obtainable from H. Coker, 18 Beechdale, London, N.21.

**"Mechanical Handling,"** our associate journal, is organizing the second Mechanical Handling Exhibition which will be held at Olympia, London, from June 6th to 17th next year.

**Packaging.**—The first National Packaging Exhibition, sponsored by the Institute of Packaging, will be held at the City Hall, Deansgate, Manchester, from October 5th to 15th. The British Standards Institution has recently issued a revised Code of Practice for packaging—BS.1133.

**Electronics Symposium.**—Among the papers to be read during the electronics exhibition at the Examination Hall, Queens Square, London, W.C.1, from November 2nd to 4th, are the following: "Electronic Amplifiers," by D. L. Banks (Furzehill); "Some Recent Improvements in Electronic Measuring Techniques," by C. H. W. Brookes-Smith and J. A. Colls (Southern Instruments); and "The Measurement of Some Transient Phenomena," by Dr. H. A. Dell (Mullard). Further particulars and tickets are obtainable from the Electronics Section of the Scientific Instrument Manufacturers' Association, 17, Princes Gate, London, S.W.7.

**Schools' Radio.**—The Essex Education Committee recently accepted tenders for the supply of £10,000 worth of radio equipment for installation in schools during 1949/50.

**Television Training School** for G.E.C. dealers in the Manchester area has been opened by the company. The course of instruction, which lasts a week, includes practical work on the diagnosis and rectification of faults in television sets.

**Amateur Radio.**—An exhibition is being held at the Corn Exchange, Manchester, from October 21st to 23rd, in connection with the R.S.G.B. National Convention. On the first day it opens at 2.30 and on subsequent days at 11 a.m. It closes daily at 9.

**Italian Television.**—It is learned from an Italian correspondent that the Italian broadcasting authorities are installing both American (625-line) and French (819-line) television transmitters near Turin with a view to conducting a series of experiments before establishing a service. One of the difficulties to be overcome in establishing a service in Italy is the non-standard periodicity of the electric mains.

**Benelux Exhibition.**—*Wireless World* and books issued by *W.W.* are among the publications of the Associated Iliffe Press being displayed in the Century Hotel, Antwerp, during the Benelux Exhibition which closes on October 9th.

## INDUSTRIAL NEWS

**Electronics Centre.**—Cinema-Television and Dawe Instruments have jointly opened a London showroom at 83, Piccadilly, W.1 (Tel.: Mayfair 4613). A wide range of test and measuring gear and electronic instruments is on show.

**British Mechanical Productions** and their associated company, the General Accessories Co., makers of Clix components, whose works are at Barton Hill Works, Maze Street, Bristol, 5, and the head office at 21, Bruton Street, London, W.1, announce that they are no longer subsidiaries of the Radio and Television Trust.

**Murphy.**—By the acquisition of General Radiological, Ltd., and Solus-Schall, Ltd., manufacturers of X-ray tubes and equipment, Murphy Radio has extended its interests to the electro-medical field.

**Radio Heaters, Ltd.,** manufacturers of Radyne industrial R.F. heaters, are building a new factory at Wokingham, Berkshire. The joint managing direc-

**World of Wireless—**

tors of the company, which was formed in 1945, are E. C. Stanley and C. E. Tibbs, who were previously in the industrial electronics department of Rediffusion, Ltd. (now Redifon).

**A. E. Cawkell**, who specializes in the design and production of electronic instruments to special order, has recently developed such apparatus as noise measuring sets, a d.c. amplifier, diathermy equipment, photometry equipment and many kinds of special-purpose amplifiers.

**Aerialite** is opening a new depot at 44-45, Suffolk Street, Birmingham.

**Wolsey Television** have opened a Midland depot at 59, Soho Hill, Birmingham, 19 (Tel.: Northern 2762 and 3493).

**Sound Sales.**—The London office and demonstration rooms of Sound Sales, Ltd., are now at Lloyds Bank Chambers, 125, Oxford Street, W.1 (Tel.: Gerrard 8782).

**Masteradio (Australia) Pty.** has been formed in Melbourne for the assembly of British Masteradio car receivers.

**EXPORT**

**India.**—Enquiries have been received by the U.K. Trade Commissioner at Madras for details of manufacturers who are able to supply dry battery or combined mains/battery receivers. Frequency coverage should be from 13 to 90 metres and 200 to 550 metres, with Indian station names marked on the dials. Manufacturers should send literature, prices and delivery dates to the Commercial Relations and Exports Dept., Board of Trade, Thames House North, Millbank, London, S.W.1, quoting reference CRE(IB) 21112/49.

**Switzerland.**—Control and surveillance radar equipment for use at the new Kloten airport is required by the Zurich authorities and they will be interested to receive offers from British firms. Communications should be sent direct to Radio Suisse A.G. Hauptpostegabaude, Berne.

**Iran.**—A report on the Iranian market for receivers has been supplied by the Commercial Counsellor at Tehran. The two main criticisms of British sets are that they are too conservative in design and seem "old-fashioned" to Persians and that they are not so extensively advertised as American sets.

**U.S.A.**—The British Consulate General at Detroit states that Buhl Sons Co. have agreed to consider offers from British manufacturers of broadcast receivers. Particulars should be sent to H. Pilbeam, Buhl Sons Co., 120, Adair Street, Detroit, Mich., U.S.A.

**Nyasaland.**—The International Marine Radio Co., of Croydon, has received an order from the Nyasaland Railways for the installation of eight shore stations and associated equipment for the provision of a radio-telephone system on Lake Nyasa.

**Radio Components** and hearing-aid parts are among the articles listed by the French authorities for token imports from this country.

**Pye (Canada), Ltd.**, a subsidiary of Pye of Cambridge, has recently opened a factory at Ajax, Ontario, for the production of television sets operating on the American 525-line system. Six prototype receivers were sent from this country and demonstrated at the Canadian National Exhibition in Toronto. As there are no television stations operating in Canada, transmissions from the American station at Buffalo (60 miles away) were received.

**MEETINGS****Institution of Electrical Engineers**

Inaugural address of the president, Professor E. B. Moullin, M.A., Sc.D., at 5.30 on October 6th.

**Radio Section.**—Inaugural address of the chairman, R. T. B. Wynn, C.B.E., M.A., at 5.30 on October 19th.

"The C.B.S. Colour Television System in the United States," by P. C. Goldmark, B.S., Ph.D., at 5.30 on October 1st.

The above meetings will be held at the I.E.E., Savoy Place, London, W.C.2.

**Cambridge Radio Group.**—Address of the chairman, C. W. Oatley, M.A., M.Sc., at 6.0 on October 11th, at the Cambridgeshire Technical College.

**North - Eastern Radio Group.**—Address of the chairman, G. E. Moore, at 6.15 on October 17th at King's College, Newcastle-on-Tyne.

**North-Western Radio Group.**—Discussion on "Wave-guides" opened by E. Colin Cherry, M.Sc. (Eng.), at 6.30 on October 19th, at the Engineers' Club, Albert Square, Manchester.

**South Midland Radio Group.**—"Hot-Cathode Thyratrons: Practical Studies of Characteristics," by H. de B. Knight, M.Sc., at 6.0 on October 24th, at the James Watt Memorial Institute, Great Charles Street, Birmingham.

**British Institution of Radio Engineers**

**London Section.**—"Experimental Study of the Magnetic Amplifier," by E. H. Frost-Smith, B.A., at 6.30 on October 13th, at the London School of Hygiene and Tropical Medicine, Gower Street, W.C.1.

**Merseyside Section.**—"The Sensitivity and Other Properties of Television Camera Tubes," by L. H. Bedford, O.B.E., M.A., B.Sc., at 7.0 on October 5th at the Accountants' Hall, Derby Square, Liverpool.

**Scottish Section.**—"Electronics in Aircraft Design," by A. L. Whitwell, at 6.30 on October 5th, at the Electrical Department, Glasgow University.

**South Midlands Section.**—"The Performance and Stability of Permanent Magnets," by A. J. Tyrrell, at 7.0 on October 27th, at the Technical College, The Butts, Coventry.

**West Midlands Section.**—"Television Receiver Design," by W. Jones, at 7.0 on October 26th, at the Technical College, Wulfrunar Street, Wolverhampton.

**British Sound Recording Association**

The date of the opening meeting of the session has been changed to September 30th at 7.0 at the Royal Society of Arts, John Adam Street, Adelphi, London, W.C.2, when W. S. Barrell will give his presidential address, which will deal *inter alia* with microgroove recording.

**Television Society**

**North Midlands Centre.**—"Single Side-band Aspects of Television," by M. Reeder, at 7.30 on September 30th, at the Great Eastern Hotel, Leeds, 1.

**Society of Relay Engineers**

"Line Equalization with Special Reference to Programme Circuits," by H. J. Marchant, at 2.30 on October 4th, at the Royal Society of Arts, John Adam Street, Adelphi, London, W.C.2.

**MANUFACTURERS'****LITERATURE**

**LEAFLET** dealing with "Sonogard" audible protection systems for works, offices, etc., from Ardent Acoustic Laboratories, Guildford, Surrey.

Descriptive leaflets No. 117 (Type MN Vacuum-cell Photometer), No. 118 ("Ionex" Ionization Meter), and No. 119 (X-ray Monitor), from the Baldwin Instrument Co., Dartford, Kent.

List of hire charges for public address equipment from Alexander Black, 34, Marlborough Grove, London, S.E.1.

"This is Ediswan," an illustrated brochure dealing with the activities and interests of the Edison Swan Electric Co., 155, Charing Cross Road, London, W.C.2.

Technical details of Type 2350E ribbon microphone, from E.M.I. Sales and Service, Hayes, Middlesex.

Leaflet describing loudspeakers and transformers made by Electro Acoustic Industries, Broad Lane, Tottenham, London, N.15.

Brochure on "Cold Welding" technique, licences for which are now being granted by the General Electric Co., Magnet House, Kingsway, London, W.C.2.

Folders describing p.a. loudspeakers, amplifiers, moving-coil microphones and type-approved schools broadcasting equipment from Magneta Time Company, Goblin Works, Leatherhead, Surrey.

Technical brochure on vibrators issued by the Plessey Co. (Components Division), Ilford, Essex.

"Television; Build it Yourself." Constructional details for assembling the television kit sold by Premier Radio, 167 Lower Clapton Road, London, E.5. Price of booklet only 2s 6d.

Catalogue of v.h.f. and h.f. radio-telephone equipment for mobile, fixed station and small craft use from Pye Telecommunications, Cambridge.

Folder of illustrated leaflets describing equipment made by Radio Heaters, Ltd., Wokingham, Berkshire.

Catalogue of S.E.I. barrier-layer photocells, and leaflet describing quartz crystals for radio communication services, from Salford Electrical Instruments, Silk Street, Salford, 3, Lancashire.



**RIGHT AT**  
**ADDISON ROAD ENTRANCE**  
**RADIOLYMPIA**  
**SEPTEMBER 28th—OCTOBER 8th**

- SWITCHES,
- CONNECTORS,
- INDICATORS,
- FUSES, etc.,
- JACKS & PLUGS,
- RESISTORS,
- NEON PRODS,
- SUPPRESSORS,
- ACCESSORIES.

The first specialised miniature radio components were manufactured by Bulgin over 25 years ago. Since then their wide range has been developed to cover every requirement of the radio and television industries.

The latest Bulgin achievement is the introduction of the first coloured components which reflect the scientific skill and practical design of all Bulgin products.

**WE WELCOME VISITORS TO**  
**STAND NUMBER ONE**  
**RADIOLYMPIA**

**BULGIN**

*Quality Electronic Components*

A. F. BULGIN & CO. LTD.,

BYE PASS ROAD, BARKING.

Telephone: RIpplway 3474 (5 lines)

# CHANGE OF ADDRESS

## The Hub of Progress



# 125 OXFORD ST., LONDON, W.1

## GERRARD 8782

# SMOOTHING CIRCUITS:

## (1) Resistance - Capacitance

**M**ANY readers have asked me to write about filters, with particular reference to smoothing circuits. This I have hesitated to do, because the subject of filters is so involved that most people like to leave it to a specialist. Most of the general books on radio take care not to embark on it at all seriously, while the books devoted specially to electrical networks almost invariably plunge the reader into a morass of hyperbolics, where he is likely to lose sight of all physical realities.

The orthodox manner of complying with the above request would be to start by dealing with the general theory of filters. That would take several months (at least), by the end of which there would be few survivors to take an interest in the application of that theory to smoothing circuits. I have therefore decided to reverse the order and start with smoothing circuits—which are of practical interest to nearly everybody—and use that familiar ground as an approach to filters in general.

Nobody ought to be encouraged to hope that he can become a proficient filter designer without prolonged study and much practice. But I do think that anybody seriously interested in radio ought to have at least a clearly defined and reliable skeleton of information on filters in place of the vague and mysterious ghost that too often haunts him.

Greatly daring, I shall attempt to construct such a skeleton without going more mathematical than usual. But if you propose to go through with it I should say beforehand that you ought to be entirely familiar with the meanings of reactance and impedance, and the standard relationships:

$$\begin{aligned} \omega &= 2\pi f \\ X_L &= \omega L \\ X_C &= 1/\omega C \end{aligned}$$

from which

$$X_L X_C = L/C$$

and  $X_L/X_C = \omega^2 LC$  ( $= 1$  at the resonant frequency  $\omega_r/2\pi$ )

$$Z = \sqrt{R^2 + X^2}$$

These formulæ for X and Z are

*How to Calculate  
the Best Number  
of Sections  
By "CATHODE RAY"*

"magnitudes" only; to take account of phase angle one has to bring in *j*.

Whenever I am reckoning with circuits I always try to have by me one of the charts or abacs connecting L, C, *f*, and X. Of the several kinds, the one I prefer has four parallel vertical scales which can be connected anywhere by a stretched thread or a celluloid

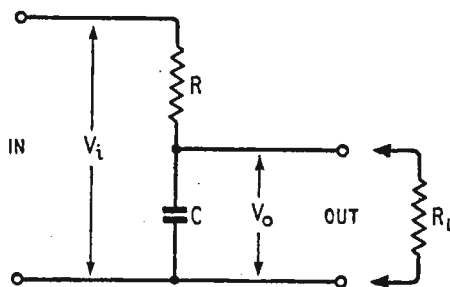

Fig. 1. The R-C filter is simply a potential divider in which the ratio varies with frequency

ruler. Among other things it shows the frequency at which any given L and C resonate, or conversely the L and C required to resonate at any given frequency. Its main use is to indicate the reactance of any L or C without any of that  $2\pi$  arithmetic in which the decimal point so often gets into the wrong place.

But it is time we finished with introductory remarks and got down to smoothing circuits.

The simplest of all is the combination of one resistance with one capacitance (Fig. 1). It is the commonest type of "decoupler," and when the current is small or the drop in voltage doesn't rule it out it is a convenient form of rectified a.c. smoother. It appears in almost every detector circuit, to filter out the r.f., and in every a.g.c. circuit, to filter out the a.f.

It works, of course, as a simple potential divider in which the impedance of the element across which the output is taken (C) is less for high frequencies than for low.

As with all potential dividers, the loss of voltage depends not only on the ratio of its two impedances, but also on the impedance connected across its output terminals—the load impedance. Unless we say otherwise, we shall assume that the load impedance is a resistance, denoted by  $R_L$ . Whenever  $R_L$  is very large compared with the impedance of the part of the potential divider it comes across (in this case  $X_C$ ) it makes calculations much easier, because then the ratio of input to output voltage ( $V_i/V_o$ ) is equal simply to the ratio of the whole impedance ( $\sqrt{R^2 + X_C^2}$ ) to  $X_C$ .

We shall call  $V_i/V_o$  the attenuation, and denote it by  $\alpha$ . If  $\alpha$  is 3, for example, it means that only one third of the input voltage reaches the output.\* In Fig. 1, then, we have

$$\alpha = \frac{\sqrt{R^2 + X_C^2}}{X_C} \quad \dots (1)$$

One should always scrutinize equations to see if they are in the most convenient form. In (1) the part that depends on frequency appears twice; so to see more clearly how it affects  $\alpha$  and to avoid needless duplication of

\* You can, of course, if you prefer, reckon  $\alpha$  in decibels, but they would have to be turned back into ratios to fit our equations.

**Smoothing Circuits—**

effort when evaluating  $a$  it is beneficial to divide above and below by  $X_C$ , with the result

$$a = \sqrt{\frac{R^2}{X_C^2} + 1} \dots (2)$$

It can be made to look even tidier, and at the same time to express the relationship more distinctly, by using any convenient symbol, say  $p$ , to denote the ratio of resistance to reactance. Then we have

$$a = \sqrt{p^2 + 1} \dots (3)$$

Using this we can draw a curve of  $a$  against  $p$  that will hold good for the Fig. 1 class of circuit in

kind of work. The dotted line in Fig. 2 is drawn to equation (5), so that you can see how the error becomes imperceptible as  $p$  increases.

As we saw last month, this type of circuit doesn't discriminate sharply between different frequencies. Its characteristic curve (Fig. 2) shows it to have a slope that approaches 6 db per octave at the high-frequency end. In other words, doubling the frequency only halves the output, at best. If it is necessary for the lower of two frequencies to be nearly 100% preserved, the reduction of a voltage at double the

being that mA and kΩ are "consistent" units). For  $a$  as large as 40 we can use equation (5), and, as the lowest frequency is 50 c/s, we find  $C = 40 / (2\pi \times 50 \times 60,000) F = 2\mu F$  approximately.  $R_L$  is  $1000/5 = 200k\Omega$ , so the shunting assumption is justified. The harmonics present are reduced 2, 3, etc., times as much, so it might seem that so long as the lowest frequency is sufficiently attenuated it won't matter about any of the others. And that is quite so when the objectionable effects of the ripple depend only on its magnitude. But it must be remembered that the sensitiveness of the ear to hum increases more rapidly with frequency than the attenuation shown in Fig. 2, so in sound-producing equipment it is necessary to do better than reduce the lowest frequency to inaudibility.

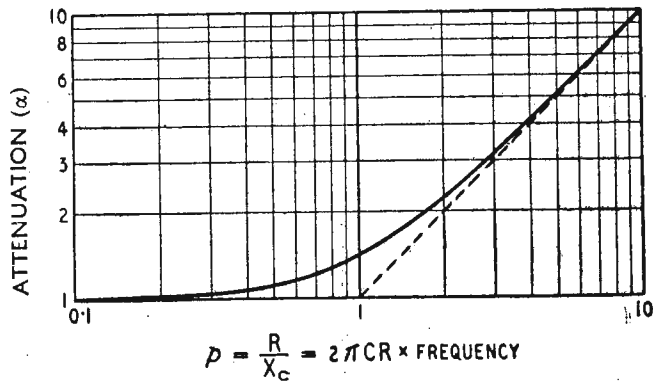

Fig. 2. Curve of attenuation against  $p$  (ratio of resistance to reactance) for a single section. This is an example of a generalized frequency curve, for  $p = 2\pi CR$  times frequency. The dotted line shows the result of making the "vector" assumption.

**Distribution of R and C**

It should be clear by now that the effectiveness of the Fig. 1 circuit depends solely on  $p$ , which is  $2\pi fCR$ , and therefore at a given frequency depends solely on the product  $CR$ . (This is not necessarily true where the effect of  $R_L$  is appreciable, but for the time being we are continuing the shunting assumption.) A specified  $a$  can therefore be obtained by any  $C$  and  $R$  which give the right figure when multiplied. But, as we have seen,  $R$  is usually dictated by the required or allowable d.c. drop, in which case  $C$  is also decided. If a very smooth output is needed, the value of  $C$  found in this way may be disconcertingly large. So we may well ask whether the Fig. 1

general (Fig. 2). Incidentally, this illustrates last month's story about generalized graphs.

Still more of a simplification can be made so long as we are aiming at a fairly large attenuation, so that  $a$  is at least several times greater than 1. For then the 1 can by comparison be neglected and we get

$$a \approx p \dots (4)$$

Up to the present I have not been able to think of any further simplification. On the contrary, in case you forget what  $p$  stands for I suggest the fuller version

$$a \approx \frac{R}{X_C} = 2\pi fCR \dots (5)$$

Remember that for (5) to be reasonably accurate it is necessary for

(a)  $R_L$  to be much greater than  $X_C$ .

(b)  $R$  to be at least several times greater than  $X_C$  (i.e.,  $a$  to be several times greater than 1).

We shall call (a) the shunting assumption and (b) the vector assumption. As an example, suppose  $R$  is 4 times  $X_C$ ; then (5) gives  $a$  as 4, which can be compared with the correct value given by (2) or (3), 4.12. The 3% error is quite negligible in this

frequency is much less still, owing to the gradualness of the bend in the region of  $p = 1$  or less. The effect of  $R_L$  not being relatively very large reduces the discrimination still more, because it cuts down the output at low frequencies without making much difference at high.

In smoothing filters, however, the only frequency to be passed is zero, so one can hardly have too much a.c. attenuation. At the very least, the lowest a.c. frequency present should come on to the main slope, and preferably as far up it as is required for the purpose in view. At the same time,  $R$  must fit into the d.c. requirements.

For example, suppose an attenuation of at least 40 is required from a half-wave 50 c/s rectifier to supply 5 mA at 1,000 V., and the output of the rectifier across the reservoir capacitor is 1,300 V. at 5 mA. The value of  $R$  is fixed at once by the voltage drop; it is  $(1300 - 1000)/5 = 60k\Omega$  (remem-

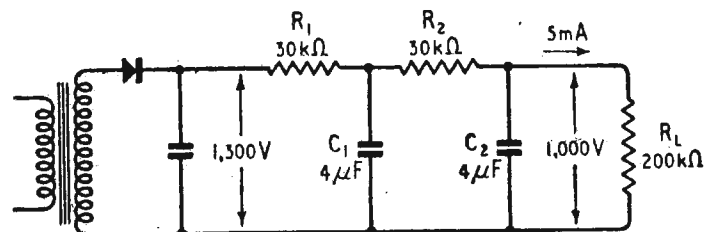

Fig. 3. Is this the best way to use these filter components?

circuit makes the best use of  $C$  and  $R$ .

Any number of units or "sections" like Fig. 1 can be used in cascade (i.e., one feeding into another), and, so long as our two



assumptions apply to every section, the  $a$  of the whole combination will be the product of the  $a$ 's of the separate sections. A second section like the first in the example just taken would reduce

below which one section is better than two. Let us call it  $p_1$ , to indicate that there is no sense in going beyond one section until  $p$  exceeds that value.

To answer the second question

TABLE I.

$n$	$p_n$	$a_n$	RC in $k\Omega\text{-}\mu\text{F}$ per section, when $f=100\text{c/s}$	$p_{s(n+1)}$
1	16	16	25.5	4
2	45.5	129	18	5.06
3	90	1,000	16	5.62
4	149	7,540	15	5.86
5	223	56,600	14	6.19
6	311	416,000	13.7	6.35

the 50 c/s content another 40 times, making the overall

$$a = 40 \times 40 = 1600$$

To keep the total voltage drop the same, the R in each section would have to be halved, so to preserve the original CR in each section the capacitances would have to be doubled (Fig. 3). A single section having the same total CR would have an  $a$  at 50 c/s of  $2\pi \times 50 \times 8 \times 60,000 \times 10^{-6} = 160$ , or only one tenth that of the two sections. In this case the advantage of splitting up is obvious enough. But is it always an advantage? And, if so, into how many sections?

Never having seen definite answers to these questions, I tackled them as follows:

Making the shunting and vector assumptions, the total  $a$  due to a given CR used all in one section (call it  $a_1$ ) is  $p$ , which is  $\omega CR$ . But if this CR is divided equally into two sections, say by halving both C and R, their product is  $CR/4$ . So the  $a$  of each section is  $p/4$ . The total  $a$  (call it  $a_2$ ) is therefore  $p/4 \times p/4 = p^2/16$ . If you try a few values for  $p$  you will find that with low values  $a_1$  is greater than  $a_2$ , but with high values it is the other way round. So that is the answer to the first question—it is *not* always an advantage to sectionalize; it depends on the value of  $p$ .

If you want to find the value of  $p$  (and hence CR) that gives the same total  $a$  whether in one section or two, you just put  $a_1 = a_2$ :

$$p^2/16 = p$$

$$\therefore p = 16.$$

So 16 is the critical value of  $p$ ,

we have to find another value— $p_2$ —above which it pays to use three sections instead of two; and so on. In general, we want  $p_n$ , the value of  $p$  at which the best number of sections changes over from  $n$  to  $n + 1$ . The calculation is made along exactly the same lines as for  $p_1$  (for details see the Appendix) and the results are given in Table I above.

Suppose you have a certain total capacitance and want to know the best way of connecting it. For example, the d.c. drop requirement gives you  $20k\Omega$ , and you have  $16\mu\text{F}$ . It is a 50 c/s full-wave rectifier, so the lowest ripple frequency is 100 c/s. So your total  $p$  is  $2\pi \times 100 \times 20 \times 16/1000 = 200$ . The table shows this is more than  $p_1$ , but not more than  $p_5$ ; so 5 is the best number of sections. The total  $a$  (third column) lies between 7,540 and 56,600; the actual value is  $(p/n^2)^n$ , in this case  $(200/25)^5 = 32,770$ . Whether it is convenient to divide your  $16\mu\text{F}$  into five equal sections is another matter, of course; you may have to make it four, at some slight sacrifice of  $a$ . But at least the table gives you something more to go on than pure guesswork.

Or you may want to find the minimum C and R for a specified attenuation, say 1000. The table shows that you can get it with three (or four) sections having sufficient total C and R to make  $p = 90$ , and (fourth column) that

Fig. 4. Summary of attenuation measurements made on filters having the same total C and R, nominal values as shown.

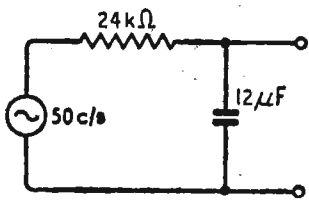
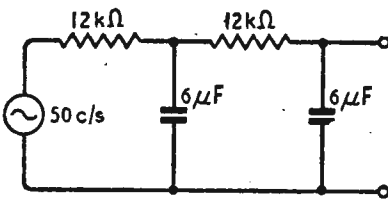
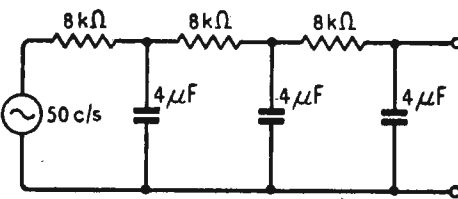
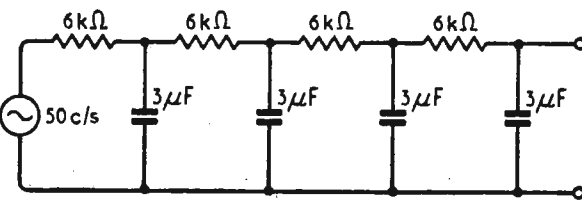
CIRCUIT	$n$	CALCULATED $\alpha$	MEASURED $\alpha$
	1	—	100
	2	$\left(\frac{100}{4}\right)^2$ = 625	690
	3	$\left(\frac{100}{9}\right)^3$ = 1,375	1,430
	4	$\left(\frac{100}{16}\right)^4$ = 1,550	2,000

**Smoothing Circuits—**

each section should be made up of 16 kilohm-microfarads.

You may wonder why I have included the last column, which shows the  $p$  per section on changing over to the next higher number of sections. For example, we saw that one section is best up to  $p = 16$ , and changing over to two sections at that point has no effect on the total attenuation, but it would reduce the  $p$  per section to 4. The last column, therefore, shows the lowest  $p$  you would ever get if you followed the table strictly. The point is that if this figure dropped to something like 2 or less, the vector assumption would be unjustified and the table would be invalid. But we see the least  $p$  is 4, with a vector error of 3%, which is not serious even when multiplied by 2. The other errors are still smaller, so are not serious even when multiplied by the larger number of sections. Such error as there is tends to make the true  $a_n$  larger and reduce  $p_n$ .  $p_1$ , for example, would be 15 instead of 16.

What about the shunting error? Even if  $R_L$  is infinitely large, so that the last section is unshunted, the last section shunts the last but one, and so on. It is difficult to

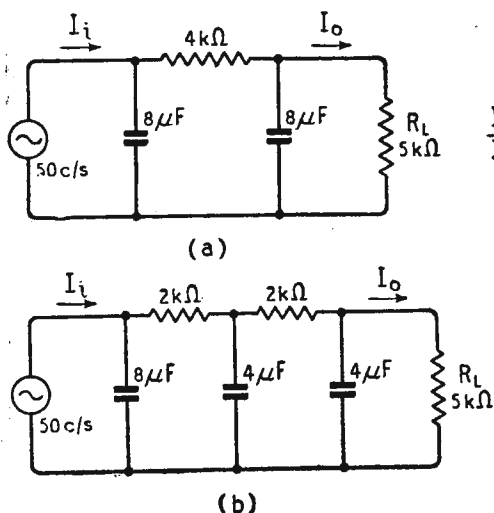

Fig. 5. Another comparative test.

work out the size of the error exactly when there are several sections, and anyway it depends on the load resistance; but the  $p_{s(n+1)}$  figures show that it ought not to be very serious, and again it would tend to make the actual attenuation and also the best number of sections higher than in the table. But since the cost of

the filter generally goes up with the number of sections, the fact that the table puts the change-over point higher than the theoretical ideal is all to the good.

Another point to be considered is that the attenuation increases in proportion to the  $n$ th power of the frequency, so in sound-reproducing equipment, at least, it is advisable to make  $n$  not less than 2.

To check the theory and to see how far its assumptions were

Fig. 6. Two methods of balancing out one ripple frequency completely—usually the lowest.

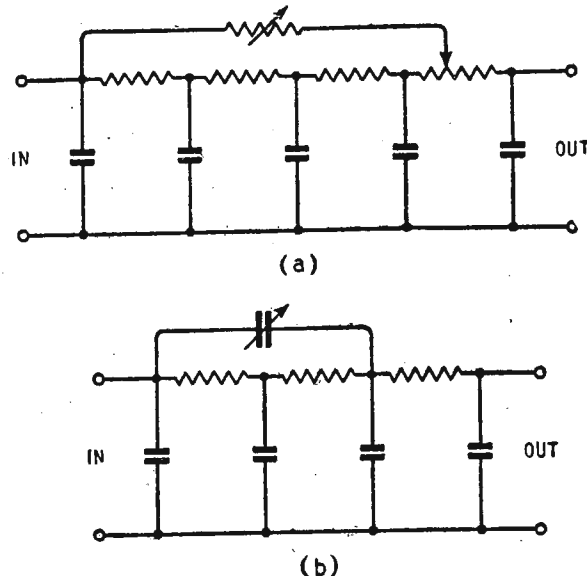

justified I did a few measurements. I aimed at  $p = 90$ , to check the middle lines in the table, but had to use the components available, so it worked out at about 100. Fig. 4 shows the nominal values, which were subject to commercial tolerances. Assuming that the measured  $p$  in one section (100) was divided exactly into 2, 3 and 4 sections, the attenuations predicted by the approximate theory were 625, 1375, and 1530 respectively. The measured attenuations (subject to possibly  $\pm 10\%$  error of measurement) were 690, 1430, and 2000. These results show that

- (a) The theoretical table is good enough for design purposes.
- (b) It tends to underestimate the results.
- (c) The discrepancy increases with the number of sections. (This is what one would expect, because the  $p$  per section is less with more sections, so the assumptions are less justifiable.)

To get still nearer to working conditions I did a test using a typical value of reservoir capacitor ( $8\mu F$ ) and load resistance ( $5k\Omega$ ), as in Fig. 5. The reservoir, without any other filtration, would reduce the hum current passing into the load. Adding one filter section having a  $p$  of about 10

made the total measured current attenuation 147. Splitting this filter section into two, the attenuation was the same. According to the approximate theory, the  $p$  for which this would happen would be 16 (or 15, correcting the vector

error). But the actual  $p$  per section in Fig. 5 (b) is only  $2\frac{1}{2}$ , so one would expect the approximate theory to be thrown out somewhat by shunting. Taking into account the higher cost with two sections, one would almost certainly want  $p$  to be at least 16 before sectionalizing.

There are at least two methods (Fig. 6(a) and (b)) for eliminating the most troublesome ripple frequency altogether. They take advantage of the fact that its phase shifts as one moves along the filter. If the right amount of ripple from the input is fed to a point where there is a  $180^\circ$  phase difference, the two will cancel one another out. There may be some occasions when these devices are worth while (such as when only a small d.c. drop is allowable), but there are several objections. One is that success depends on both magnitude and phase being correctly adjusted. Another is that only one frequency is cancelled; for the others the attenuation of the original filter (admittedly relatively high for the higher frequencies) is actually reduced. It is necessary to use several sections to get the required phase shift, and the table has shown us that quite a large  $a$  can be obtained with several sections straightforwardly, without going beyond reasonable limits for CR. Still another disadvantage is that the necessary design information would increase the length of this

article, and it is already full size. Calculation of actual hum voltage, and inductance-capacitance filters must wait until next month.

APPENDIX

(Showing how to calculate the table giving the number of sections for maximum attenuation).

$$p = 2\pi f \times \text{total CR.}$$

If CR is divided into  $n$  equal sections, the attenuation per section is approximately  $p/n^2$  (assuming that it is at least several times greater than 1, so that the simplifying assumptions apply). The total attenuation,  $\alpha_n$ , is therefore

$$\alpha_n \approx \left(\frac{p}{n^2}\right)^n$$

If the same CR were divided into

$n + 1$  equal sections the attenuation would be

$$\alpha_{n+1} \approx \left(\frac{p}{(n+1)^2}\right)^{n+1}$$

If  $p_n$  is the value of  $p$  that makes  $\alpha_n = \alpha_{n+1}$ , then approximately

$$\left(\frac{p_n}{n^2}\right)^n = \left(\frac{p_n}{(n+1)^2}\right)^{n+1}$$

$$\therefore \frac{p_n^{n+1}}{p_n^n} = p_n = \frac{(n+1)^{2(n+1)}}{n^{2n}} \dots (A)$$

$$\text{So } \alpha_n \approx \left(\frac{p_n}{n^2}\right)^n = \left[\frac{(n+1)^{2(n+1)}}{n^{2n} \times n^2}\right]^n = \left(\frac{n+1}{n}\right)^{2n(n+1)} \dots (B)$$

And  $p_{s(n+1)}$  (the  $p$  per section when  $p_n$  is divided into  $n + 1$  sections) is

$$p_{s(n+1)} \approx \frac{(n+1)}{n} \alpha_n \approx \left(\frac{n+1}{n}\right)^{2n} \dots (C)$$

supplies up to 500 volts at 1 amp, or on low voltages up to 10 amps. High-grade Bakelite is employed

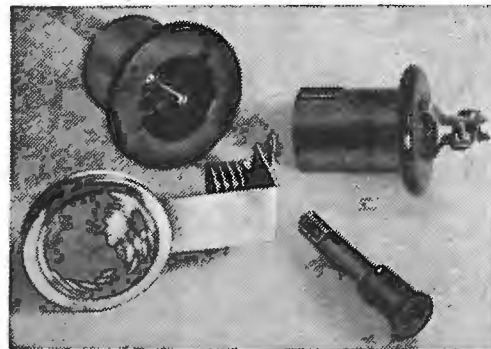

Bulgin accessories comprising a two-pin connector, signal lamp and a car ignition interference suppressor.

# MANUFACTURERS' PRODUCTS

## New Plessey Components

SEVERAL new components have been introduced recently by the Plessey Company, Vicarage Lane, Ilford, Essex. One is a ceramic type B8A valve holder with floating nickel silver contacts having a wide



Plessey ceramic B8A valveholder and (below) solid moulded-track volume control.



lead-in angle, which should prevent any likelihood of bent pins or a fractured base provided that the "float" in the socket is not destroyed by stiff wiring. It has a metal centre spigot tube, which also serves as an earthing contact, and a base screening shield incorporating a locating keyway. The inter-socket capacitance is between 0.1 and 0.2 pF while; between all sockets and earth, the capacitance is less than 0.15 pF, a very necessary feature for v.h.f. applications.

There is a laminated plate-type valveholder for the B9A valves having silver-plated phosphor

bronze contacts giving a firm but sound electrical contact with the valve pins.

A volume control, having a solid moulded resistance element contained in a moulded body, is also among the new items. It is designed to be very robust and reliable in operation. Resistance values range from 100 ohms to 2 megohms, while the minimum values, often called the "hop-on" and "hop-off" values, are kept down to 1.0 per cent of the track resistance, or 50 ohms in the lower values. The track will safely carry some direct current so that their usefulness is extended to television controls and cathode bias circuits.

Conventional single-hole fixing is employed and either single- or double-pole on-off switches can be incorporated.

## Some Useful Accessories

THE introduction of a new signal lamp fitting taking a modified "Pigmy Sign" mains bulb of 15 watts rating adds some fifty further varieties of signal fittings to the already extensive range made by A. F. Bulgin and Co., Ltd., Byepass Road, Barking, Essex.

The new signal lamp has a B.E.S. screw fitting for the bulb and a 1½in diameter plastic lens which is secured in position by means of three springy tongues and slots cut in the annular ring of the back plate. This plate is riveted to a bracket carrying the B.E.S. lamp holder. Ten varieties of coloured lenses are available and the metal rim can be finished in a wide range of colours and styles. The price is 2s 3d.

Another recently introduced Bulgin product is a fully insulated non-reversible moulded connector. In a 2-pin type it will handle mains

and although the normal colour is black other shades can be supplied to order.

The non-reversible feature is obtained by a moulded key on the withdrawable socket part and a corresponding keyway in the fixed plug housing. This is a useful feature for d.c. sets. A cable grip is also included. Two-, three- and six-pin connectors are available and the prices are 5s 9d, 6s 3d and 8s 3d respectively.

An interference suppressor for motor car engines has now been added to this firm's range of accessories. It is a plug-in type for the distributor head and is inserted in the lead to the coil. The suppressor resistor is wire wound and is enclosed in a flexible weatherproof moulding. The price is 1s 6d.

## New Television Receiver

THE 15-inch tube in the Model 1806 H.M.V. gives a picture size 12½in x 10in and it is claimed that the aluminized screen gives sufficient brilliance for viewing by normal room lighting. The price is £148 4s 5d, with tax.



H.M.V. Model 1806 receiver.

# Unbiased

By FREE GRID

## North of the Border

TELEVISION aeri-als are not a very conspicuous feature of the Scottish landscape at present. This is not very surprising as Scotsmen very sensibly like to have value for their money and freak reception from A.P. has no attractions for them. In fact, the only installation I actually saw on a recent visit there was owned by a mad dog of an Englishman, but that was not very surprising for, as Noel Coward reminds us, they are apt to do odd things such as going out hatless in the midday sun in the tropics. Licence figures, too, show that there is a dearth of Scottish television installations. I cannot refrain from mentioning, however, that doubts as to the accuracy of licence figures were aroused in my mind when I noticed that some of the "Monarchs of the Glen" showed no signs of movement even when I got to wind'ard of them; their antlers, too, seemed staggeringly symmetrical.



"Staggeringly symmetrical."

In spite of the apparent dearth of television in Scotland, however, I was privileged to witness a better and clearer picture on a television screen than any I have ever seen down here. It was in the saloon of one of those pleasure steamers which convey holiday-makers through the lovely lochs of Scotland. The scene on the screen was merely the same as could have been viewed by going on deck and looking over the side. It was coming from a closed circuit transmitter

mounted for'ard. The idea behind the scheme was to enable passengers to view the surrounding scenery in comfort during inclement weather. It was proposed, so I was told, to mount a screen in front of each seat in the saloon and to arrange for it to be switched on by the insertion of a sixpence.

I need hardly say that the promoter of this money-losing scheme is an Englishman who has omitted to do anything in the way of "market research." As I told him, if he, or anybody else, seriously thinks that a sixpence can be extracted from a Scotsman as easily as this he is very much mistaken. I pointed out that a much simpler plan would be to forego the sixpence and merely provide in the saloon a pre-taken cine-film of the passing scenery. The Scots at home are simple-minded folk—it is only the astute ones who come south—and they wouldn't know the difference between a cine-film and television. They don't know what the latter looks like and are not likely to for many a long day, despite B.B.C. and Government promises. In fact, my opinion of the authors of these promises is aptly expressed by the words of Macbeth about the double-crossing witches, or, better still, by Mr. Asquith's famous "wait and see."

## "Electronicometry"

THE extent to which the technique of radio and electronics is pervading even the most commonplace aspects of our daily lives was brought home to me very vividly a short time ago when I spent one of the last sad days of dying summer at a popular seaside resort. It goes almost without saying that the place had a pier, that strange and bizarre mixture of Byzantine and Victorian architecture which would be tolerated in no other country but England. I stood meditating for a while among the serried ranks of the ubiquitous what-the-butler-saw machines; I was once told at a political meeting that they were installed by the bloated plutocracy at a time when butlers were in short supply in order to induce youths to rush to fill the gaps in their ranks.

The butler has long since gone—he probably died of shock. In return for my penny I was regaled with the sight of some ultra-modern bathing beauties which, I was informed, came to me by cour-



"I heaved up the platform."

tesy of "Seymour Swim-Suits Limited"—very limited, judging by the dimensions of some of the "water-wear."

I was about to leave the pier in search of a shrimp tea when I was attracted to a machine calling itself an electronic brain. It claimed to give my height and weight without any resort to the usual principles of mechanics. In appearance it was much the same as the usual weighing machines except that it had an extra dial for recording height and also a large box-like canopy suspended over the platform.

It was, of course, quite easy to see how the height was calculated as the box-like canopy overhead contained radar apparatus which merely measured the distance of the top of my head from itself and then subtracted it from the known distance to the platform on which I stood. The method of ascertaining my weight did, however, puzzle me and I suspected that the ordinary mechanism of levers and what-not was being used. To settle the question I heaved up the platform with the aid of my umbrella and a monkey wrench which I usually carry about with me and was astounded to find nothing but a stout spiral spring supporting the platform at each corner.

It was not, in fact, until I had sat far into the night in my cell at the local police station that I realized how it worked. The overhead radar gear had measured the distance down to the top of my head when I first stood on the platform, thus giving my height, and then had measured it again when the spring-borne platform and myself had sunk a fraction of an inch under the influence of gravity. The difference between these two readings would, of course, give my weight.

# Vortexion

## SUPER FIFTY WATT

This **AMPLIFIER** has a response of 30 c/s. to 25,000 c/s. within  $\frac{1}{2}$  db, under 2 per cent distortion at 40 watts and 1 per cent at 15 watts, including noise and distortion of pre-amplifier and microphone transformer. Electronic mixing for microphone and gramophone of either high or low impedance with top and bass controls. Output for 15/250 ohms with generous voice coil feedback to minimise speaker distortion. New style easy access steel case gives recessed controls, making transport safe and easy. Exceedingly well ventilated for long life. Amplifier complete in steel case, with built-in 15 ohm mu-metal shielded microphone transformer, tropical finish.

As illustrated. Price **36½ Gns.**



## CP20A. 15 WATT AMPLIFIER



for 12 volt battery and A.C. Mains operation. This improved version has switch change-over from A.C. to D.C. and "stand by" positions and only consumes  $5\frac{1}{2}$  amperes from 12 volt battery. Fitted mu-metal shielded microphone transformer for 15 ohm microphone, and provision for crystal or moving iron pick-up with tone control for bass and top and outputs for 7.5 and 15 ohms. Complete in steel case with valves.

As illustrated. Price **£28 0 0.**



## 30 WATT RECORD REPRODUCER

This amplifier has been produced for extremely high quality gramophone or microphone quality in large halls or in the open. An output power of 30 watts is obtainable at under 1% distortion after the output transformer which is arranged for 4,  $7\frac{1}{2}$ , or 15 ohm output. The most noticeable point is the absence of background noise or hum.

Very generous feedback is employed to help out any distortion developed by the speaker and the large damping factor ensures good transient response. The usual response of 30 to 25,000 cycles plus or minus  $\frac{1}{2}$  db is given, and recording compensation of 5 db per octave lift below 300 cycles is obtainable on the gramophone input by means of a switch. A carefully balanced treble control is arranged to correct top lift on some recordings as well as to reduce scratch on old records without noticeable effect on frequencies below 3,500 to 4,000 cycles. The input is intended for the high fidelity type of pick-up and is fully loaded by an input of .2 volts on 100,000 ohm or  $\frac{1}{4}$  meg. ohm as required. The microphone stage requires an input of .3 millivolts on 15 ohm balanced line through the wide response mumetal shielded microphone transformer. An octal socket is fitted at the rear of the chassis to provide power for feeder units, etc., 6.3 volts at 2 amps and 350 volts at 30 milliamps is available

Complete in well ventilated steel case. Price **30½ Gns.**



## EXPORT

Enquiries from Overseas will receive prompt attention. Continental Buyers are invited to get into touch with our Belgian Agents:

Ms. Constant L. Bisman,  
129 Avenue de la Reine,  
Bruxelles  
Téléh. 16.10.31.

## FOUR WAY ELECTRONIC MIXER

This unit has 4 built-in, balanced and screened microphone transformers, normally of 15-30 ohms impedance. It has 5 valves and selenium rectifier supplied by its own built-in screened power pack: consumption 20 watts. Suitable for recording and dubbing, or large P.A. Installations since it will drive up to six of our 50 watt amplifiers, whose base dimensions it matches. The standard model has an output impedance of 20,000 ohms or less, and any impedance can be supplied to order. Price in case with valves, etc., **£24.**

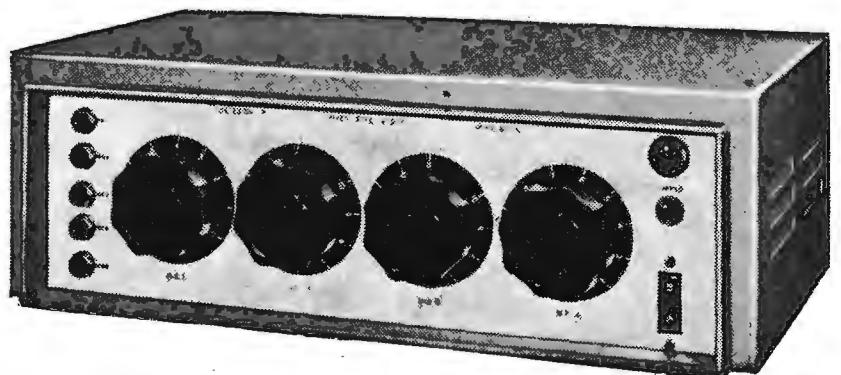

VORTEXION LIMITED, 257-261 THE BROADWAY, WIMBLEDON, LONDON, S.W.19  
Telephones: LIB 2814 and 6242-3  
Telegrams: "Vortexion, Wimble, London"

# Our Success Story . . . is shared with our Students

The increasing demand for our HOME STUDY and DAY COURSES in Radio, Television and Kindred Electronic subjects, compels us to move to larger premises. At our new address we shall have much more accommodation for staff, larger and better equipped classrooms and laboratories and improved boarding facilities.

## ★ 91% PASSES ★

In recent City & Guilds examinations, our candidates were remarkably successful. No less than 91% achieved passes. A large proportion of which were "first classes".

*WRITE FOR FREE BOOKLET which gives full details of all courses. In addition to HOME STUDY there are the following DAYTIME courses:*

PRINCIPLES & PRACTICE OF RADIO —  
1 Year.

TELECOM. ENGINEERING — 2 Years.  
(City & Guilds Final Certificate)

ELECTRONICS ENGINEERING — 3 Years.  
including 1 year in E.M.I. Factories.  
(City & Guilds Full Technological Certificate)

P.M.G. MARINE AND AIR RADIO  
OPERATORS 1st Class Certificates.



## E.M.I. INSTITUTES

*Associated with "H.M.V.", Marcomphone, Columbia, etc.*

E.I.53

Dept. 127, 43, Grove Park Road, Chiswick, W.4 Telephone: CHiswick 4417/8



Our new premises in Pembridge Sq. W.2 (3 minutes from Notting Hill Gate) will be opened early in 1950.

## WELL PAID CAREERS.

Letter from SIR BEN LOCKSPEISER, M.A., M.I.Mech.E., F.R.Ae.S. when Chief Scientist to the Ministry of Supply to Professor Trewwan, the Principal.

"I am much interested in the courses of training in electronics at E.M.I. Institutes. Apart from the obvious need for such trained people in the Radio and Television industry, there is a rapidly increasing demand in very many other fields . . . . . Although scientists possessing University Degrees are required in increasing numbers, many times this number of skilled technologists are needed . . . . . We look forward to receiving the names of your students when their courses are complete".

# ELECTRONIC CIRCUITRY

## Selections from a Designer's Notebook

By J. McG. SOWERBY (Cinema Television Ltd.)

SOME months ago it was pointed out in these columns<sup>1</sup> that a cathode follower is sometimes used for stabilizing the current in a television cathode-ray tube focus coil. As this aroused some interest it

### Direct Current Stabilizers

has been thought worth while to present the following brief notes on current stabilizers in general, as they have various laboratory uses, one of which is the stabilization of the currents in the lens coils of an electron microscope.

Normally a current stabilizer is required to stabilize not only against fluctuations of the supply mains, but also against changes of resistance of the component through which an unvarying current is required. To be definite, let us call this component a coil whose resistance (if wound with copper wire) will change with temperature. A significant change in temperature may well be caused by the power dissipated in the coil when the current is flowing.

Current stabilizers may be looked at in two different ways, and it is largely a matter of personal preference which is chosen, as they lead to the same conclusions. If the coil is placed in series with a resistance of value high compared with that of the coil and a correspondingly high voltage applied to the two components in series, then changes of coil resistance will have little effect on the current flowing, provided the supply voltage is constant. For example, if the series resistance is ten times the coil resistance, a change of one per cent in the resistance of the coil will represent a change of only 1/11 per cent in the total resistance, and the percentage current change is similarly reduced by a factor of eleven.

A straightforward current stabilizer for a coil of resistance 5,000

ohms to be supplied with 20 mA might be constructed as indicated in Fig. 1. This arrangement would discriminate against mains fluctuations by the stabilization ratio of the voltage stabilizer, and against coil resistance fluctuations by a factor of eleven. The supply voltage required is  $55 \text{ k}\Omega \times 20 \text{ mA} = 1,100 \text{ volts}$ . The power to be supplied is equally easy to calculate and is  $1,100 \text{ volts} \times 20 \text{ mA} = 55 \text{ watts}$ , and of this total power only  $5 \text{ k}\Omega \times (20 \text{ mA})^2 = 2 \text{ watts}$  is actually supplied to the coil. Thus the arrangement is very wasteful of power, and this is only one of its faults.

By the use of a device capable

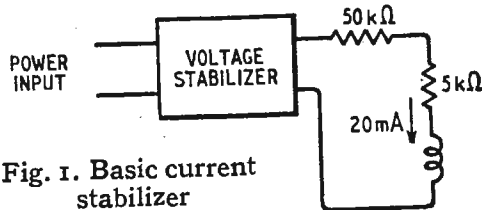

Fig. 1. Basic current stabilizer

of passing a useful current at a reasonable voltage, and yet having a high (a.c.) resistance to changes of current a much more economical circuit can be designed. Such a circuit is that shown in Fig. 2.

Here  $V_1$  is a triode whose effective internal resistance is increased from  $r_a$  (the normal anode resistance of the valve) to

$$R_0 = r_a + (\mu + 1) R_k$$

where  $\mu$  = amplification factor.

$V_2$  is a stabilizer tube whose running potential is  $V_n$ , and this supplies a nominally constant grid bias to  $V_1$ . If we make the assumption—which is nearly true for a high- $\mu$  valve—that the potential across  $R_k$  is also  $V_n$ , we may re-write the internal resistance as

$$R_0 = r_a + \frac{(\mu + 1) V_n}{i}$$

where  $i$  = required stabilized current.

Putting in practical values of  $R_a = 3 \text{ k}\Omega$ ,  $\mu = 28$  (for an EF55)  $V_n = 85 \text{ volts}$  (for an 85A1) and

$i = 20 \text{ mA}$ , we find  $R_0 = 126 \text{ k}\Omega$ . If the coil resistance  $R_c = 5 \text{ k}\Omega$  the coil will drop 100 volts at 20 mA so that the coil and  $R_k$  together account for 185 volts. If a supply potential of 350 volts is used, 165 volts will appear across the valve, and, at this anode voltage, reference to the valve curves shows that no grid current flows.

In such an arrangement the effect of a change of coil resistance of one per cent on the current flowing is reduced to about 0.04 per cent. The total resistance in the circuit is  $(126 + 5) = 131 \text{ k}\Omega$ , so that if the h.t. supply line changes by 10 per cent (35 volts), the change in current is only  $35/131 = 0.27 \text{ mA}$ , or rather less than 1.5 per cent of the total coil current. The total power consumed (excluding the stabilizer tube circuit) is  $350 \text{ V} \times 20 \text{ mA} = 7 \text{ watts}$ , and of this, 2 watts is supplied to the coil. This contrasts very favourably with the arrangement of Fig. 1.

The circuit of Fig. 2 can be looked at a second way in which the coil is regarded as having a resistance  $R_k$  in series with it,

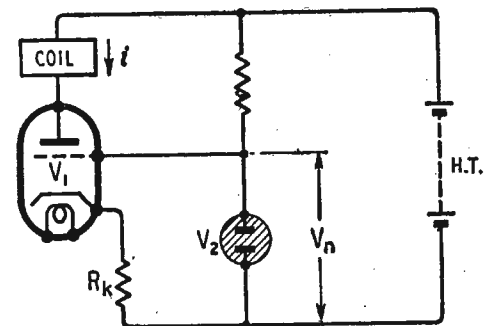

Fig. 2. Simple practical current stabilizer

and the aim is to maintain a constant voltage across  $R_k$ . Obviously if the voltage across  $R_k$  is unchanged, and  $R_k$  remains unchanged, then the current through  $R_k$  must remain unchanged. As any current that

<sup>1</sup> Wireless World, September, 1948, p. 322.

**Electronic Circuitry—**

flows through  $R_k$ , also flows through the coil, the coil current must also remain unchanged. This way of looking at the circuit quickly leads one to the more refined and effective circuit of Fig. 3.

In Fig. 3,  $V_1$  and  $V_2$  correspond to  $V_1$  and  $V_2$  in Fig. 2, but now an amplifier valve  $V_3$  has been interposed. As this valve is actually a cathode-coupled pair it amplifies the difference in potentials applied to the two grids. One of these potentials is the reference potential  $V_n$  derived across  $V_2$ , and the other is that

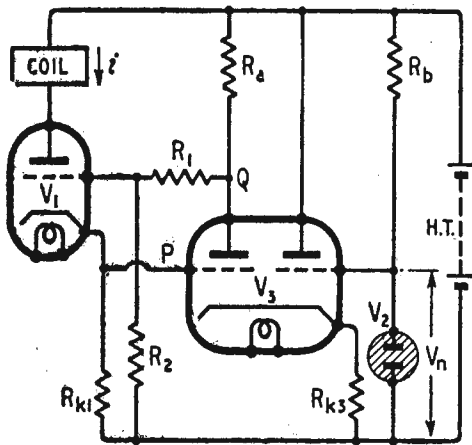

Fig. 3. More advanced current stabilizer

across  $R_{k1}$ . The amplified signal across  $R_a$  is applied via the potentiometer chain  $R_1, R_2$  back to the grid of  $V_1$  in such a way as to tend to maintain the potential across  $R_{k1}$  equal to  $V_n$ . Analysis shows that the effective resistance in series with the coil is increased by the introduction of the amplifier valve  $V_3$ . It is found that for this circuit

$R_0 = \mu_1 A_3 V_n / i$  approximately where  $\mu_1$  = amplification factor of  $V_1$ .

$A_3$  = gain from cathode to grid of  $V_1$  through  $V_3$ .

In practice it is not easy to make  $A_3$  much greater than 10, and if each triode of  $V_3$  has  $\mu_3 = 70$ , the cathode coupling will restrict the gain from P to Q to less than  $70/2$ —say 25, and a further loss of  $1/2$  will take place from Q to the grid of  $V_1$  if  $R_1 = R_2$ . So much loss in the  $R_1 R_2$  coupling chain is a consequence of the need to maintain the correct standing potentials at P and Q. The choice  $R_1 = R_2$  is often convenient, and

the anode-cathode potential of the left-hand side of  $V_3$  will be nearly equal to  $V_n$ .

Taking practical values of  $\mu_1 = 28$  (EF55),  $V_n = 85$  volts,  $i = 20\text{mA}$ ,  $A_3 = 10$ , we find the effective resistance  $R_0 = 1.2\text{M}\Omega$  (approximately) in series with the coil. Making the assumption\* that  $V_n$  is constant, the effective stabilization ratio to the cathode of  $V_1$  is approximately  $S_0 = \mu_1 A_3$  ( $= 280$  for the values assumed above), so that discrimination against both mains fluctuations and changes of coil resistance is very good. One point is rather important; as the coil current is determined by the current through  $R_{k1}$ , it is imperative that this component shall be highly stable, and low temperature coefficient wire-wound resistors should be used. To control the value of the stabilized current it is generally best to switch in different values of  $R_{k1}$  for large changes, and to vary the effective value of  $V_n$  for small changes by arranging for the right-hand grid of  $V_3$  to be connected to the slider of a potentiometer across  $V_2$ , so that the effective  $V_n$  can be varied (say) from 85 to 70 volts.

The informed reader will have recognised that the arrangement of Fig. 3 closely resembles a voltage stabilizer, and other voltage stabilizer circuits were ably described recently in this journal.<sup>2</sup> The interested reader will be able to adapt these other circuits in the

represents the ultimate in performance, although it is satisfactory for a variety of applications.

RESISTANCE-coupled phase splitters were discussed at length in this journal<sup>3</sup> some time ago, and these may broadly be divided into low- and high-gain types. Examples of the latter are

**Neutralizing Phase-splitters**

the cathode-coupled and see-saw phase-splitters. Some designers of these circuits avoid the use of triodes, because of the increase of input capacitance due to the Miller effect. It is not always realized that neutralization can often be employed, and this may, in some circumstances, be a material aid in maintaining the response at the higher frequencies.

Fig. 4 shows a cathode-coupled phase-splitter driven by some previous amplifier stage S. Those who studied the recent article on the Miller effect (August issue) will remember that the anode-grid capacitance  $c_{ag}$  is effectively multiplied by the gain of  $V_1$  from grid to anode, and appears effectively between the grid of  $V_1$  and earth. Thus, although  $c_{ag}$  may be only 3 or 4 pF, the effective input capacitance of  $V_1$  may be up to 100 pF, and this may be serious if S is a pentode of the 6J7 type, with a high-resistance anode load.

This large input capacitance is a consequence of the fact that any

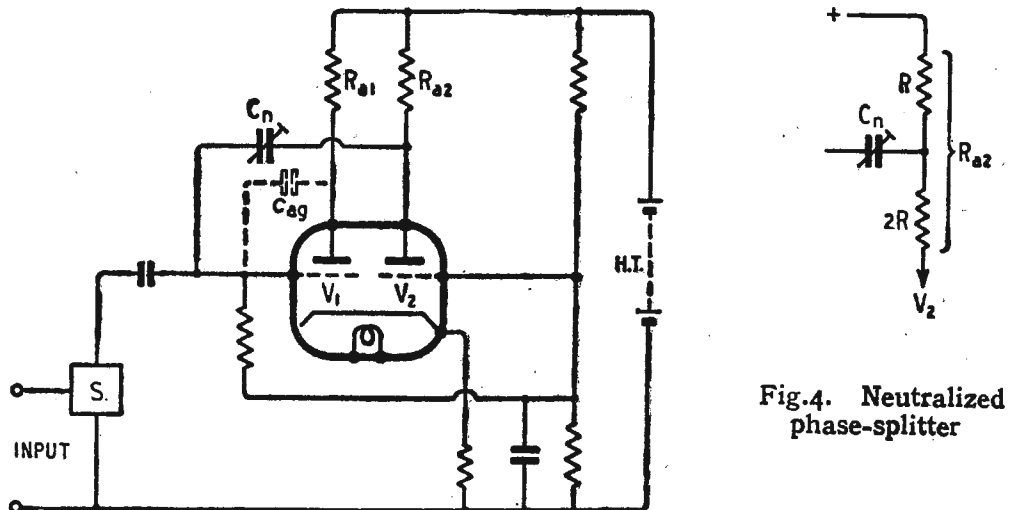

Fig.4. Neutralized phase-splitter

light of what has been said above, and it may be remarked that the circuit of Fig. 3 by no means

signal voltage at the anode of  $V_1$  is out of phase with that at the grid. But the signal at the anode of  $V_2$  is fortunately in phase with

\* Only true when  $R_b$  is very much larger than the effective resistance of  $V_2$ .

<sup>2</sup> "Stabilized Power Supplies," M. G. Scroggie, *Wireless World*, Oct., Nov., Dec., 1948.

<sup>3</sup> W. T. Cocking, *Wireless World*, Jan., Feb., March, April, May, 1948, with particular reference to April, p. 126 and May, p. 163.



**Electronic Circuitry—**

that at the grid of  $V_1$ . Hence a neutralizing capacitance  $C_n$  equal to  $c_{ag}$  may be connected as shown and the undesirable effects of  $c_{ag}$  are neutralized at ordinary frequencies where the amplifier behaves essentially as a resistance-coupled stage. The actual capacitance of  $c_{ag}$  is practically never more than 5 pF, so that  $C_n$  must be restricted to some value not more than this. It is often convenient\* to split  $R_{a2}$  (as shown at the side of Fig. 4) so that signal voltage fed to  $C_n$  is reduced by a factor of three. This enables an

\* But theoretically incorrect. However, the method is legitimate as long as the anode resistances from which  $c_{ag}$  and  $C_n$  are fed are very low compared with the reactances of  $c_{ag}$  and  $C_n$ . This is nearly always the case in practical circuits up to about 20 kc/s.

ordinary r.f. trimmer (e.g. 5-15 pF) to be used, and avoids the necessity for a special component.

A good method of adjusting the circuit is to apply a square waveform to the input of S (frequency about 1 kc/s for audio amplifiers), view the output on an oscilloscope and adjust  $C_n$  for the best results. This method generally leads to slight over-neutralization, but this is only undesirable if carried to excess so that the circuit is on the verge of oscillation.

This method of reducing the input capacitance of amplifiers was used in some radar circuits, and for further information the reader is referred to "Waveforms," Chance, Williams, Hughes, Mac-Nichol and Sayre, *M.I.T. Rad. Lab. series*, Vol. 19, p. 767. McGraw Hill.

over any distances from this country during October.

It is not likely that Sporadic E will be much in evidence.

Ionospheric storms are often prevalent during October and some considerable periods of poor communication are therefore to be expected. At the time of writing it appears that ionospheric storms are most likely on 8th-9th, 18th-21st and 24th-26th.

Starting this month it is intended to give the predicted working frequencies for four long-distance circuits running in different directions from this country in graphic, instead of in tabular, form, as hitherto. Although the graphs are largely self-explanatory, the following few words may be said about them. A dashed line in each graph indicates the predicted m.u.f. for the circuit for each hour of the day, average for the month—and thus represents the highest frequency which should be usable at each hour for fifty per cent of the total time. The full line indicates the so-called o.w.f.—the frequency below which it should be possible to maintain regular communication: i.e., on every day of the month except those during which ionosphere storms are in progress. The dot-dashed line is for the use of those whose primary object is the working of certain bands; it gives the highest frequency likely to be usable at each hour for about 25 per cent of the time.

# SHORT-WAVE CONDITIONS

## August in Retrospect : Forecast for October

By T. W. BENNINGTON (Engineering Division, B.B.C.)

**DURING** August the average daytime maximum usable frequencies for these latitudes were somewhat higher than during July, whilst those for night-time were appreciably lower. This is in conformity with the usual seasonal trend, and m.u.f.s should now continue this type of variation towards the winter. Daytime working frequencies were, therefore, fairly high, though not high enough to permit regular use of frequencies like the 28-Mc/s band. Night-time frequencies of 9 Mc/s were often needed on some circuits.

Sunspot activity during the month was, on the average, considerably higher than during July.

Sporadic E was prevalent during the month, though somewhat less so than during July; and medium-distance communication on high frequencies by way of the medium was frequently possible. It is expected that the rate of incidence of Sporadic E will now decrease rapidly.

August was a much more disturbed month than July, one long period of 14 days never being quite free of disturbance. This was 3rd-16th, the other disturbed period being 29th-31st. Most severely disturbed days were 3rd, 4th, 5th and 8th. "Dellinger" fadeouts were reported on 5th (2), 11th, 16th, 17th, 20th and 31st, those of 5th, 17th and 31st being intense.

Long-range tropospheric propaga-

tion does not appear to have been very frequent during the month.

**Forecast.**—During October daytime m.u.f.s in the Northern Hemi-

sphere will continue to increase, and, towards the end of the month, should reach exceptionally high values. It is unlikely, however, that they will be so high as those reached during the same period of the last two years. Night-time m.u.f.s should continue to decrease.

Working frequencies for long-distance communication should therefore be high by day, frequencies like the 28-Mc/s band being frequently—if not regularly—usable over most transmission paths. At night 9 Mc/s should be about the highest regularly usable frequency, and lower ones will be necessary for some circuits. It is not expected that the E or  $F_1$  layers will control transmission

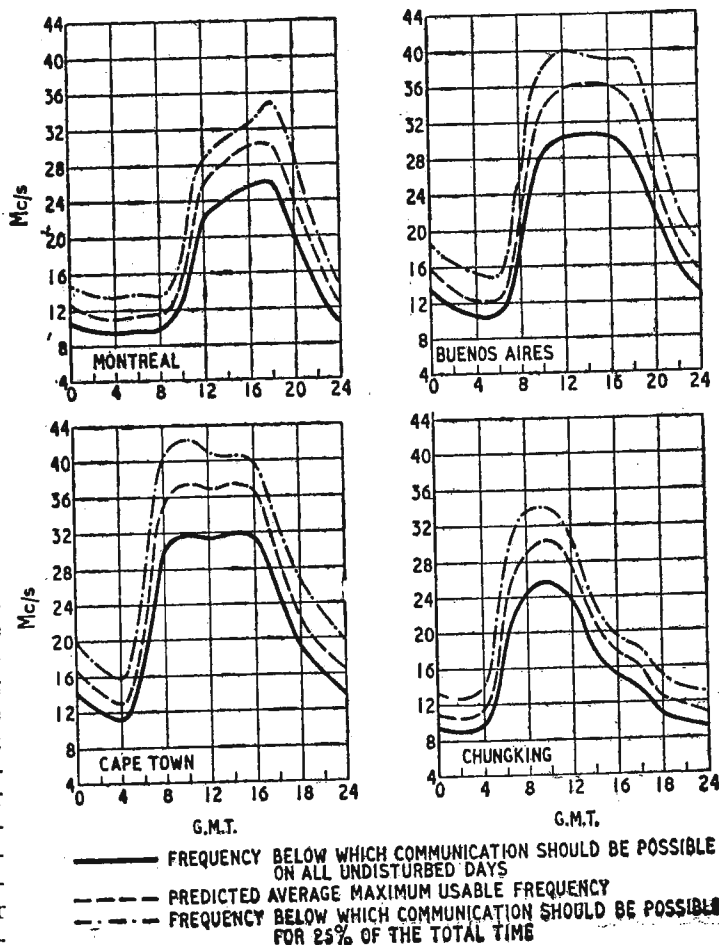

# VENTED LOUDSPEAKER

## Basis of Design to Match Existing Loudspeaker Units

By C. T. CHAPMAN (Goodmans Industries)

THE large irregular plane baffle, or, better still, a baffle of "infinite" dimensions, such as a hole in a wall, although basically representing the optimum method of loading

provides a promising approach to the problem.

The equivalent circuit of a loudspeaker mounted in a vented cabinet, Fig. 1 (a) is shown at (b), where  $L_c, C_c, R_c$  represent the diaphragm mass, the acoustic capacitance or compliance of the suspension system, and the resist-

value can be obtained from the loudspeaker manufacturer, although on a standard product, which may have a nominal resonance of say 55 c/s, the manufacturer's tolerance may well be 10 c/s. It is therefore advisable to check the resonance of the actual unit, although, as is explained later, certain variations in resonance can be obtained in the cabinet by change of vent length.

A second consideration is the area required for the vent. This should be equal to the piston area of the loudspeaker diaphragm so that

$$\text{Vent area} = \pi r^2 \quad \dots (1)$$

where  $r = \frac{1}{2}$  piston diameter of diaphragm.

The initial enclosure volume  $V$  is obtained by equating the expressions for the reactances  $C_v$  and  $L_v$  which are equal at resonance and solving for  $V$  as originally proposed by Hoekstra. It will be shown later that this initial

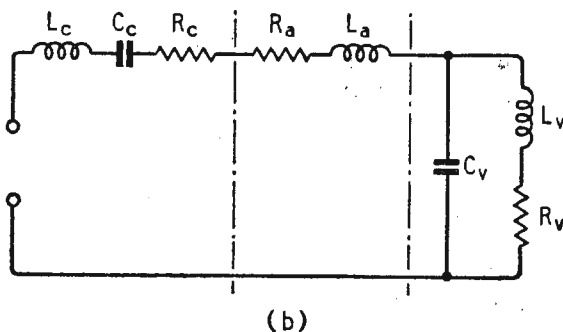
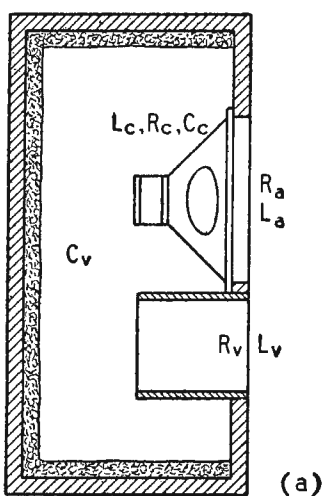

Fig. 1. Section of vented cabinet loudspeaker (a), and, (b), equivalent electrical analogue.

for a direct-radiator type loudspeaker, is seldom practicable. The result is that the baffle dimensions are reduced below the minimum required for the proper development of the lower frequencies. The musical balance is upset, and, even more serious, the loudspeaker diaphragm may develop excessive amplitudes, resulting in intermodulation and harmonic distortion. This effect is often unwittingly worsened by the user, who, in an attempt to obtain increased bass output, provides bass boost in his amplifier equipment.

The problem is a very real one, for, to provide adequate loading on the diaphragm down to 55 c/s, a plane baffle 10 feet in diameter is required, with attendant difficulties of construction, maintenance of rigidity, etc.

The basic requirement is to increase the radiation resistance at the lower frequencies, and it can be seen that the use of a Helmholtz resonator or a vented chamber

of the suspension system respectively,  $R_a$  and  $L_a$  the resistance and inductance of the air loading on the front of the diaphragm.  $C_v$  is the acoustical capacitance of the enclosed volume, and  $R_v$  and  $L_v$  the acoustic radiation resistance and inductance of the vent.

$C_v$  and  $L_v$  are proportioned to resonate at the same frequency as the effective mass and compliance ( $L_c$  and  $C_c$ ) of the loudspeaker diaphragm, thus reducing the diaphragm excursions and the output directly radiated at this frequency.

Also, since the phase difference between the volume currents in  $L_v$  and those generated at the immediate rear of the diaphragm may be as much as  $180^\circ$ , the sound issuing from the vent may be in phase with that directly radiated.

A primary design consideration, therefore, is a knowledge of the loudspeaker resonant frequency, so that the enclosure dimensions can be determined. The exact

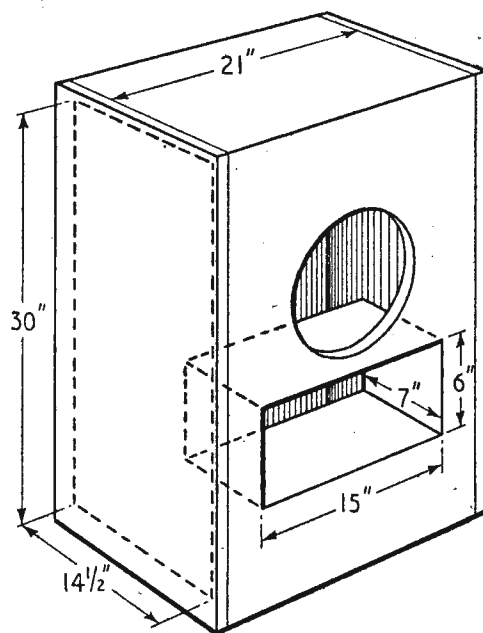

Fig. 2. Dimensions of a typical cabinet, designed to match a 12in (10in effective) diameter loudspeaker with a fundamental resonance of 57 c/s.

# CABINETS

volume must be modified before the final enclosure volume  $V_1$  is determined.

Thus the capacitive reactance of the enclosed volume is:—

$$X_{cv} = \frac{c^2 \rho}{\omega V} \dots (2)$$

where  $V$  = the initial volume.  
 $\rho$  = density of air.  
 $c$  = velocity of sound in air.  
 $\omega = 2\pi f$ .  
 $f$  = loudspeaker resonant frequency.

and the reactance of the mass of air in the release opening is

$$X_{Lv} = \left[ \frac{\omega \rho}{\pi r^4 k^3} \right] K_1(2kr) + \frac{\rho \omega l}{\pi r^2} \dots (3)$$

and equation (3) will reduce to

$$X_{Lv} = \frac{3.4 f \rho}{r} + \frac{2 f l \rho}{r^2} \dots (4)$$

Equating  $X_{cv}$  and  $X_{Lv}$  an expression for  $V$  is obtained:

$$V = \frac{c^2 r^2}{4 \pi f^2 (1.7 r + l)} \dots (5)$$

As can be seen from equation (5), changes in resonance of a given enclosure may be effected by modifying the length of the vent.

Although it is desirable to obtain the minimum volume; the vent should only be extended to the centre of the enclosure as shown in Fig. 1 (a), so that it may be lengthened or shortened as necessary to obtain the

final adjustment to compensate for the cabinet makers' tolerances, and the exact loudspeaker resonance.

It must be remembered that both the loudspeaker and the vent will displace a volume which must be added to  $V$  to obtain the final volume  $V_1$  on which the cabinet size is based.

The final dimensions of an enclosure of the required volume will be a matter of personal taste and convenience, but the basic design of a cabinet which has been used in various forms with reliable results is as follows:

The loudspeaker is a standard 12in model with an actual piston

Fig. 4. Impedance curves of unit with 57 c/s resonance in various baffles. (1) No baffle, (2) Vented cabinet of Fig. 2, (3) Diaphragm clamped, (4) Infinite baffle (hole in wall).

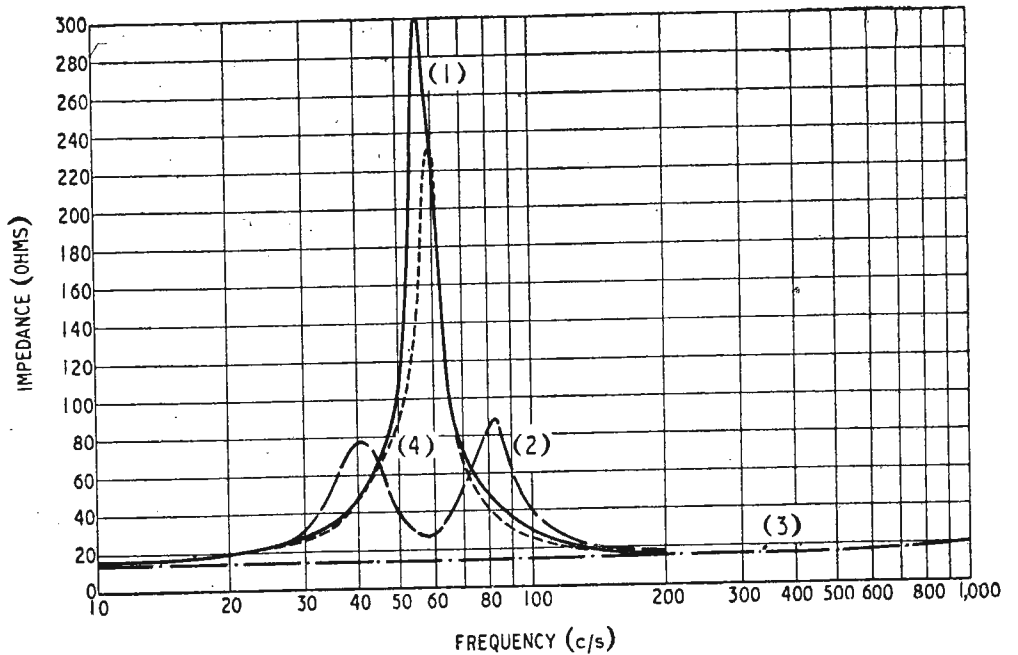

diameter of 10in. Then with a resonant frequency of 57 c/s, suggested length of vent 7in,  $c = 1185$ ft per sec and  $r$  and  $l$  in inches.

$$V = \frac{1185^2 \times 12^2 \times 5^2}{4 \pi 57^2 \times 15.5} = 8,000 \text{ cu in.}$$

Volume of vent = 540 cu in.

Volume of loud-speaker =  $\frac{200}{740}$  "

$\therefore$  Final cabinet volume  $V_1 = 8,000 \text{ cu in} + 740 \text{ cu in} = 8,740 \text{ cu in.}$

Suggested dimensions:

- Height 2ft 6in
- Width 1ft 9in
- Depth 1ft 2in.

With area of vent 80 sq in.

When the original cabinet was made, as shown in Fig 2, it was decided to have the vent variable in length for measurement purposes, and to enable a correction to be made, if necessary, to the final resonance figure.

Fig 3 shows the effect on the impedance curve of changing the resonance of the loudspeaker. Changing the unit for the one for which the cabinet was designed, with a free air resonance of 57 c/s, various measurements were taken as shown in Fig 4. The free air impedance curve of this unit is typical of the normal high-flux 12in unit obtainable to-day, and,

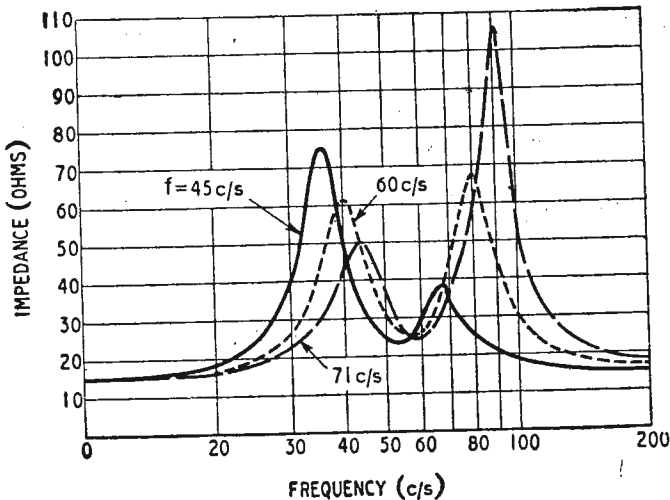

Fig. 3. Effect of cabinet of Fig. 2 on speech-coil impedance curves of loudspeaker units with resonances other than the design frequency of 57c/s.

where  $l$  = length of vent  
 $k = 2\pi/\lambda$   
 $\lambda$  = wavelength  
 $K_1$  = Bessel function of first order  
 $r$  = radius of opening =  $\frac{1}{2}$  piston dia. of diaphragm

and  $\rho$ ,  $\omega$  and  $f$  are as defined for equation (2).

A series which may be substituted for the factor  $K_1(2kr)$  is

$$\frac{2}{\pi} \left[ \frac{(2kr)^3}{3} - \frac{(2kr)^5}{5} + \frac{(2kr)^7}{7} - \dots \right]$$

If  $f$  remains less than 150 c/s and  $r$  is less than 25 cm, the second and third terms of this series may be neglected with sufficient accuracy,

**Vented Loudspeaker Cabinets**— as can be seen at (1) of Fig 4, rises to almost astronomical heights at resonance. When put in the cabinet, however, with the anti-phase resonance at the same frequency, the result can be seen at (2) of Fig 4, with the diaphragm clamped at (3), and mounted on a baffle of "infinite" dimensions at (4). Variations of vent length from 4in to 7in and 10in give the resonances of 63.5, 58 and 53 c/s respectively, equal to those for cabinet volumes

of 9,800, 8,000 and 6,700 cu in respectively, when the vent length is kept at 7in.

The basic formula in this article has been used successfully over a wide range of requirements, from a cabinet housing a 6in speaker with a bass resonance of 130 c/s up to four 18in speakers each with a resonance of 50 c/s. It is, however, imperative in all designs that the cabinet be rigidly constructed, for any resonance in the individual panels will cause a sharp attenuation at the fre-

quency concerned, and, if the resonance is particularly severe, the panel itself will radiate.

It is necessary to line the inside of the back, top and bottom of the cabinet with felt or cotton wool in butter muslin to minimise standing waves.

**REFERENCES**

Rayleigh. "Theory of Sound," Macmillan.  
 C. E. Hoekstra. "Vented Loudspeaker Enclosures." *Electronics*, March, 1940.  
 F. Olson. "Elements of Acoustical Engineering," van Nostrand, Macmillan.  
 F. W. Smith. "Resonant Loudspeaker Enclosure Design." *Communications*, August, 1945.



General view of the instrument.

**I**N television, it is often necessary to be able to measure high voltages, but the internal impedances of their sources are usually so high that ordinary methods are inapplicable. The electrostatic voltmeter is particularly useful because it draws no current from the source in d.c. measurements.

It consists essentially of a variable capacitor to the rotor of which is attached a pointer. The rotor is spring-loaded so that in the absence of any force acting to enmesh the vanes the capacitor

is always at its minimum value. On connecting a high-voltage source to the capacitor it becomes charged and the electric field between the plates exerts a mechanical force which tends to enmesh the plates. The rotor plate actually does move, carrying with it the indicating pointer, and comes to rest when the force produced by the electric field balances the restoring force of the spring.

Usually the rotor has a single vane and the stator one or two. The clearance between them is considerable—often as much as 1/4in—so that the capacitance is very small. It is commonly of the order of 20 pF.

With vanes of straight-line capacitance, the instrument has a square-law scale, but in practice, it is usual to shape the vanes to give an approximately linear scale. The shaping is usually such that the scale is cramped at each end and open in the middle.

The electrostatic voltmeter can be used with alternating as well as direct supplies and measures the r.m.s. value of a sine waveform. It is independent of frequency as long as its capacitance current is negligibly small.

If it is fed through a diode, it becomes a peak voltmeter indicating the peak value of alternating waveforms. An instrument of this kind is shown in the photographs and the arrangement is given in the circuit. It is built around a 3 1/2-in meter of 5 kV full-

scale reading; the instrument used was actually a Government-surplus type covering 1-5 kV.

For use as a normal electrostatic voltmeter, connection is made to terminals 1-2. For use as a peak voltmeter, connection is made to terminals 2-3. The valve is a

# HIGH - VOLTAGE MEASUREMENT

## R.M.S. and Peak Values



Interior view showing the valve and batteries.

Mullard EY51 with its filament heated from two No. 8 torch batteries. As shown in the circuit, the instrument measures the peak value when the input makes terminal 3 positive with respect to terminal 2.

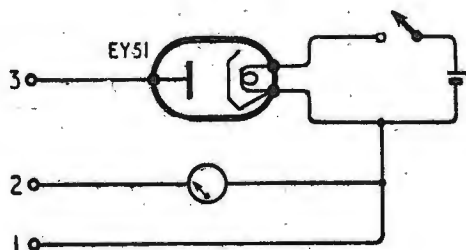

Circuit of electrostatic meter and peak-measuring diode.

*Marconiphone  
invites you to  
a grand 'stand' view*

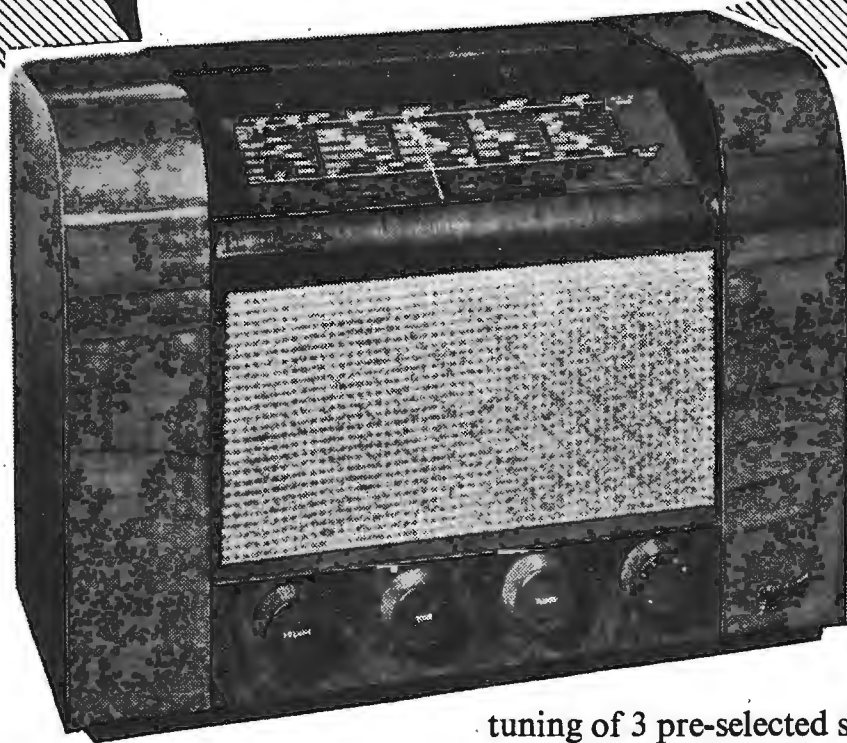

### AT OUR RADIOLYMPIA STAND

*Here you will be welcome to inspect the complete range of Marconiphone products which includes Television, Radio, Record Players, Valves and Batteries.*

*Make a point of seeing this new low-priced Model T21A which represents the finest value for money in radio today. It is a five-valve, three-wave-band table receiver for A.C. Mains (195/255 volts 50-100 cycles) with the following special features ● Astonishing tonal fidelity due to new form of negative feedback ● "Spot-on"*

*tuning of 3 pre-selected stations as well as flywheel manual tuning ● Inbuilt aerial fitted—only mains connection needed for normal requirements ● Sockets for pick-up or record player ● Provision for external loudspeaker with special plug/switch for selection of Internal/External loudspeakers ● Handsome walnut cabinet with brown moulded control knobs ● Price £17.19.6 plus £3.17.11 Tax.*

# MARCONIPHONE

THE GREATEST

*Marconi*

NAME IN RADIO

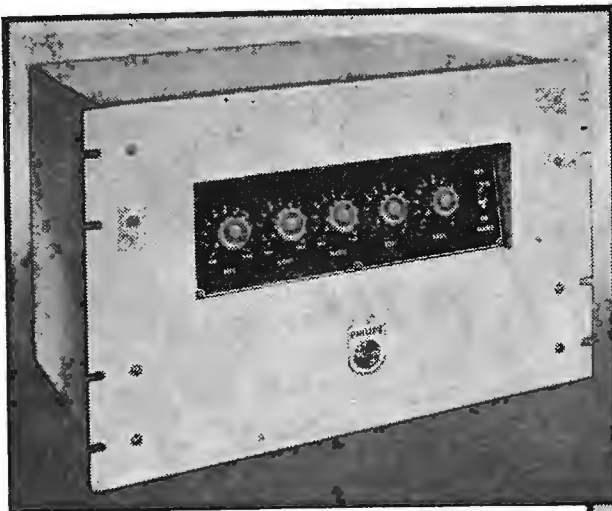

**A new amplifier . . .** The outstanding features of this new Philips Amplifier include: A high degree of voltage amplification; an output of 100 watts; and very little waste heat, giving cool running and long life. An unusual feature is that the output is well maintained even at extremes of the audio spectrum, and generous negative feedback taken over the output transformer provides excellent loudspeaker damping. List price 100 guineas.

Full range of literature available  
*A complete range of literature covering the full Philips range of S.R.E., and an extensive new price list, are now available upon request.*

# Latest additions to the PHILIPS range of sound reproducing equipment

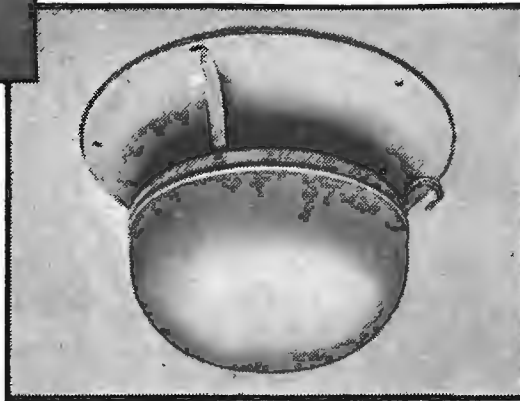

## A new loudspeaker

This new Philips all-metal Central Diffusion Loudspeaker is for ceiling mounting or suspension. It is attractively finished in a pleasing shade of cream that will harmonize well with any type of surrounding. Dimensions are 15 in. diameter, 8 in. deep. A Philips type 9803 unit is fitted in the loudspeaker which has a 100 volt transformer tapped for 1, 3 and 6 watt operation. List price £7



**PHILIPS ELECTRICAL**  
 LIMITED

AMPLIFIER DEPARTMENT, CENTURY HOUSE, SHAFTESBURY AVENUE, LONDON, W.C.2

(A509A)

# G.E.C. QUARTZ CRYSTAL UNITS

## For Reliable Radio Communications



From take-off to landing, the safety of passengers, cargo and machines is largely dependent on trouble-free radio communication.

Weather reports, conditions at terminal airports etc., must be reported to aircrews.

Navigation by radio beacons plays an important part in keeping the planes flying safely on their assigned routes.

Be sure, then, that the Quartz Crystal Units in your radio equipment are the best obtainable, for they are the most critical components.

Pioneering research and experience in making over a million units, ensure a product of the finest available quality at competitive prices. We can give rapid delivery for your urgent requirements.

When the requirement is exceptionally urgent, phone Middleton (Lancs.) 2424 or Temple Bar 4669 (London).

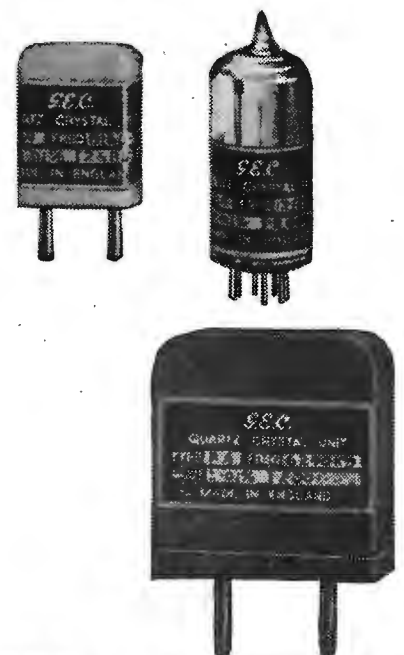

**SALFORD ELECTRICAL INSTRUMENTS LTD.** PEEL WORKS · SILK ST. SALFORD 3 · LANCs.

A Subsidiary of THE GENERAL ELECTRIC CO. LTD. OF ENGLAND

# REFLEX VALVE VOLTMETER

By  
M. G. SCROGGIE, B.Sc., M.I.E.E.

## A Simple but Effective Method of Stabilization

**M**OST present-day valve voltmeters have as their basis a pair of similar valves with the meter connected between cathodes or anodes. This arrangement, which by itself is suitable

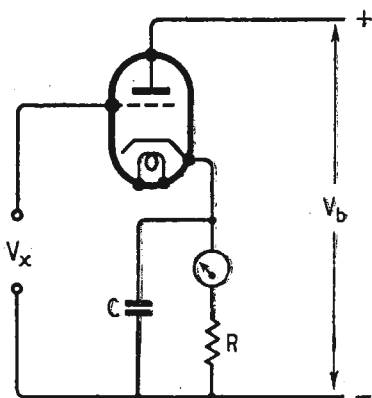

Fig. 1. Reflex (or automatic slide-back) valve voltmeter in its simplest form.  $V_x$  is the voltage to be measured. If the input terminals are liable to be open-circuited, an internal high resistance across them is desirable.

for d.c. measurements, is usually supplemented by a diode rectifier for a.c. Although the effective mutual conductance of the pair of meter-driving valves used in this way is only half the actual  $g_m$  of one of them, at least they can be worked on the "straight" of their characteristics, where  $g_m$  approaches its maximum. If the valves are well matched, their comparatively large anode current under these conditions is automatically balanced out, and this balance is unaffected by changes in anode voltage. The diode gives linear rectification over a large range of input voltage, which is not limited by the supply voltage available for the instrument.

Yet for some purposes, especially for level indicators incorporated in signal generators,\* etc., this three-valve voltmeter is rather

more elaborate than one may wish. And although the zero setting is stable (always assuming that the valves really are similar), the calibration depends directly on the valves'  $g_m$  and hence indirectly on the anode voltage. Provided that one is not chiefly interested in measuring very low or very high voltages, there is still a lot to be said for what is generally known as the reflex valve voltmeter, but which can also be regarded as an automatic slide-back type.

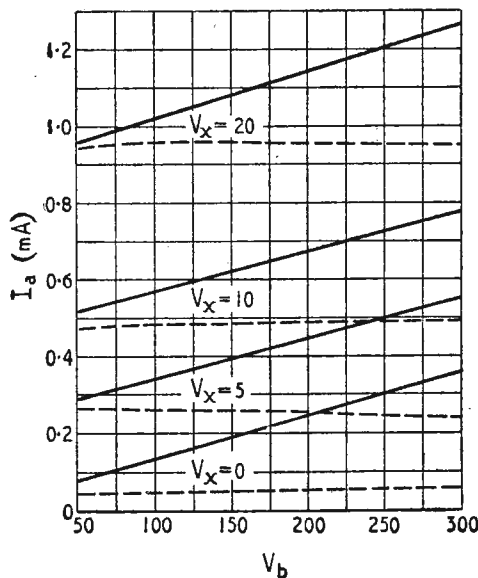

Fig. 2. The full lines, which apply to the circuit of Fig. 1, show how the meter deflection depends on the supply voltage,  $V_b$ . The readings were taken with  $R = 25 \text{ k}\Omega$ ,  $\mu = 30$ ,  $g_m$  (nominal) =  $3.5 \text{ mA/V}$ , and  $C = 50 \text{ }\mu\text{F}$ ; and  $V_x$  is specified in r.m.s. values of 50-c/s sinusoidal voltage. The dotted lines show the effect of adding  $R' (= \mu R)$  (Fig. 4), in this case  $750 \text{ k}\Omega$ .

As Fig. 1 shows, it is extremely simple. Compared with the diode type, which in some ways it resembles, it has the advantage that the "signal,"  $V_x$ , is relieved of the burden of supplying the power in the load resistance, so

the input impedance can be very high even although the meter current may be as much as several milliamps. On the other hand, the maximum voltage that can be measured is limited to something less—generally a good deal less—than the supply voltage,  $V_b$ .

Before discussing the functioning and design of this type of voltmeter in detail, let us note the important improvement that was incorporated in the example just cited. In its simplest form (Fig. 1), the system suffers from the disadvantage that both the zero setting and the calibration depend on  $V_b$ . This fact is shown by the full lines in Fig. 2, the results of readings taken with the circuit values stated thereunder. As we see, the "zero" current (i.e., with  $V_x = 0$ ) is very closely proportional to  $V_b$ . In some applications  $V_b$  may be far from constant and it may not be convenient to use a voltage stabilizer. The very appreciable zero current is also a nuisance.

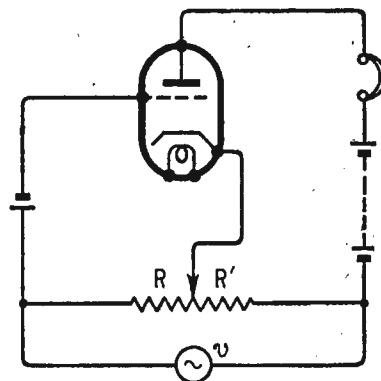

Fig. 3. Well-known method of measuring  $\mu$ , showing basis of stabilizing method (Fig. 4).

A simple and effective way out of both difficulties can be derived from the classic  $\mu$  circuit for the measurement of  $\mu$  (Fig. 3). Except for the presence of  $R'$  this is essentially the same as Fig. 1,

\* For example, the audio signal generator described in the August and September issues.

**Reflex Valve Voltmeter—**

the output,  $v$ , of the generator representing changes in  $V_b$ . The ratio of  $R'$  to  $R$  is adjusted until there is no signal in the valve

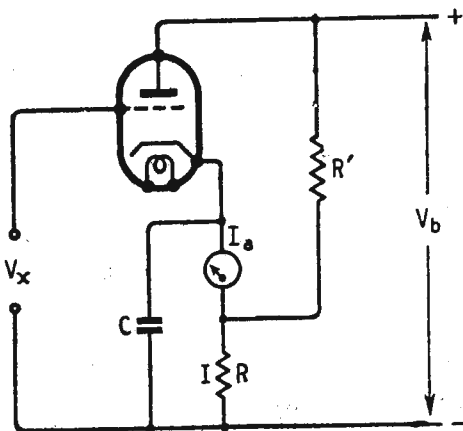

Fig. 4. Adding  $R' (= \mu R)$  to Fig. 1 very effectively stabilizes the instrument against variations in  $V_b$ , as demonstrated by Fig. 2.

circuit. Then  $\mu = R'/R$ . Put another way, the value of  $R'$  required in this circuit to prevent changes in supply voltage from causing changes in valve current is  $\mu R$ . All that is needed to stabilize the reflex valve voltmeter against variations in  $V_b$ , then, is to add  $R'$  (Fig. 4). Even though  $g_m$  and  $r_a$  vary considerably as the working point of a valve is shifted, and also when the valve ages,  $\mu$  remains nearly constant; so once  $R'$  has been correctly set for a given  $R$  and valve it can be relied upon to remain correct.

It may not be obvious at first glance that this stabilization will necessarily hold good under signal-handling conditions, over the full range of measurement; so we shall look into that when considering the working in detail. But in the meantime the dotted lines in Fig. 2 offer experimental evidence that a fixed value of  $R'$  does, in fact, give almost perfect stabilization not only at zero but also at any signal level. In this case at least, variations in zero setting and in calibration are hardly appreciable over a supply voltage range of 50 to 300. Not only so, but the zero current is so much reduced that devices for balancing it out are unnecessary.

Heater voltage is not likely to vary so much as  $V_b$ ; a reduction of 15% (which is certainly outside good practice) was found to affect

a mid-scale reading by less than 2%.

Let us first consider the voltmeter in its Fig. 1 form. *Mutatis mutandis*, the same consideration applies to the so-called infinite-impedance detector.

The zero condition is easily ascertained from the appropriate  $I_a/V_g$  curve (Fig. 5) by drawing a load line (the reciprocal of its slope representing  $R$ ) from the origin  $O$  and noting the point of intersection  $A$ . This point indicates the initial meter current and the bias developed by it in  $R$ . For strict correctness the usual constant- $V_a$  characteristic curve would have to be "de-sloped" slightly to allow for the fact that  $V_a$  becomes progressively less than  $V_b$  as the current is increased; this can easily be done, of course, but is hardly worth while in practice, as the difference is trifling.

Both for rectification and for

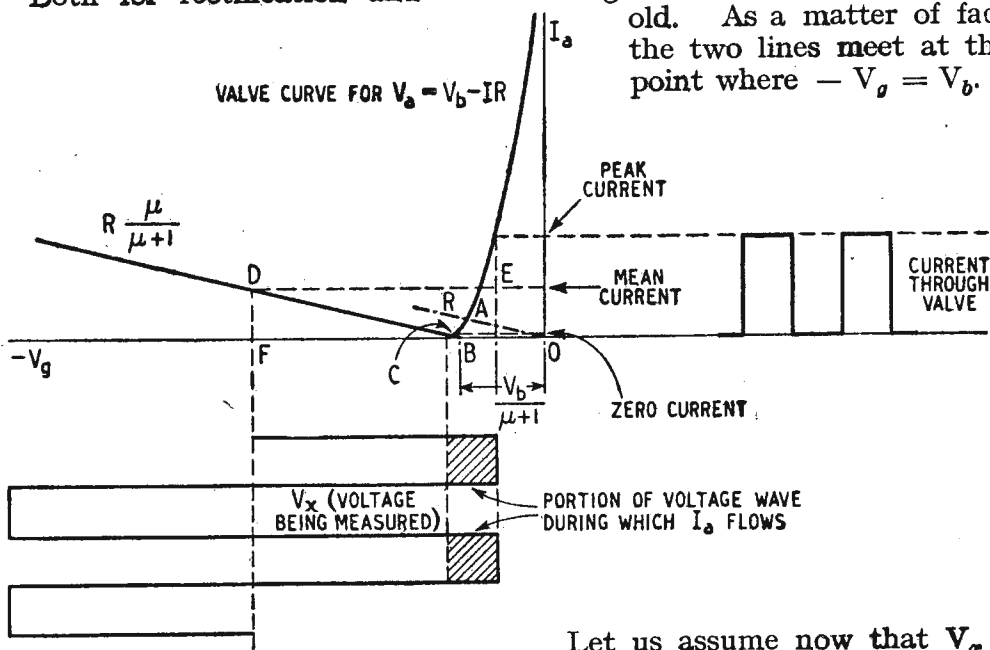

Fig. 5. Diagram illustrating detailed operation of reflex valve voltmeter and how it can be designed to fulfil given conditions. The simplest case—symmetrical square-wave input—is shown.

minimizing the "zero" current it is clear that  $R$  should be large enough for its line to cut the valve curve low down.

Considering now the effect of  $R'$ , we see that the supply current flowing through it develops a bias across  $R$  equal to  $V_b R / (R + R')$ , which can be allowed for in the diagram by making the load line start this distance to the left of the origin, at  $B$ . With  $R' = \mu R$ , this bias is equal to  $V_b / (\mu + 1)$ .

The original load line  $OA$  will from now on be ignored.

The new load line cuts the valve curve at  $C$ , and it is obvious at once how the "zero" current is greatly reduced. The rectification of small signals is not necessarily improved, because this part of the valve characteristic usually approximates to a parabola, which is notable for rectifying equally at all points. In any case the small-signal rectification is poor.

When current flows through  $R$  from the valve, the voltage across  $R'$ , and therefore the current through it, alters; so it might appear that the bias represented by  $OB$  is affected. This is not so if, making use of the Principle of Superposition, we regard the load resistance as  $R$  and  $R'$  in parallel, which is equal to  $R\mu / (\mu + 1)$ , and draw the load line accordingly. In practice  $\mu \gg 1$ , so that the slope of the new load line is hardly distinguishable from that of the old. As a matter of fact the two lines meet at the point where  $-V_g = V_b$ .

Let us assume now that  $V_a$  is large enough to sweep well around the bend. The negative half-cycles are almost completely suppressed in the output circuit, while the positive voltage half-cycles reach the steep part of the valve curve and produce large current pulses. These quickly charge up  $C$ , increasing the voltage drop across  $R$ , and the working point is driven up the load line to the left, reducing the current amplitude and also (except with square waves) the portion of each cycle during which current can flow. This double reduction in mean current limits the leftward movement of the working point and brings it to a stop at the position



(say D) where the mean value of the current pulses is equal to the value of the continuous smoothed current flowing through R.

Such a condition is represented by the input-voltage and output-current waves shown in Fig. 5. (For strict accuracy, again, the valve curve used to find point C would not be correct for tracing out the current pulses; the appropriate  $I$  in  $V_b - IR$  is now the constant mean current at point D. The difference is unimportant qualitatively, or even quantitatively if  $V_x$  is small relative to  $V_b$ .) A symmetrical square-wave input is shown, because it simplifies matters by making the mean current exactly half the peak value. If therefore the full-scale current of the meter is given, the peak current is known. At the most it ought not to be allowed to reach the point where grid current starts to flow. When, by one consideration or another, the greatest mean current has been fixed, the load resistance for a given voltage range can be determined by setting off the peak voltage along the line ED and drawing the load line through D and B. For a multi-range voltmeter the several values of R (and of course R') can thus be quickly worked out.

With other waveforms the process is considerably complicated by the fact that the ratio of peak to mean current increases as  $V_x$  is increased, and of course one does not know exactly what  $V_x$  is

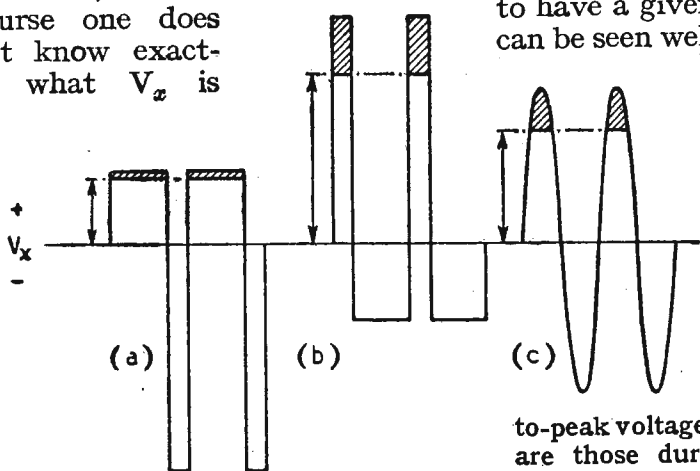

Fig. 6. The arrows indicate the relative meter deflections (i.e., mean currents) obtained with (a) an unsymmetrical square wave, (b) the same reversed, and (c) a sine wave having the same peak-to-peak voltage. The shaded portions are those during which  $I_a$  flows. In (b) the duration of current flow is one-third that in (a), so the amplitude of current would have to be three times greater to yield the same mean value. Actually the mean value is between two and three times greater. So care must be taken that peaky waves do not drive the valve into grid current. The deflection due to a sine wave is intermediate.

without knowing the ratio of peak to mean. It can be done on the diagram by trial and error, or algebraically if one can find an equation to represent the valve characteristic; but in practice probably the best way is to use the diagram to gain a clear picture of the working and then correct

the estimated departure from square-wave values by experiment. Another alternative, which is recommended for the light it sheds on the process, is the analysis described by G. L. Hamburger in *Wireless Engineer*, May, 1949, pp. 147-153.

If the portion of the signal voltage wave during which anode current flows (shown shaded in Fig. 5) could be reduced to a very small fraction of the whole amplitude, then the instrument's deflections would sensibly be proportional to peak values. They

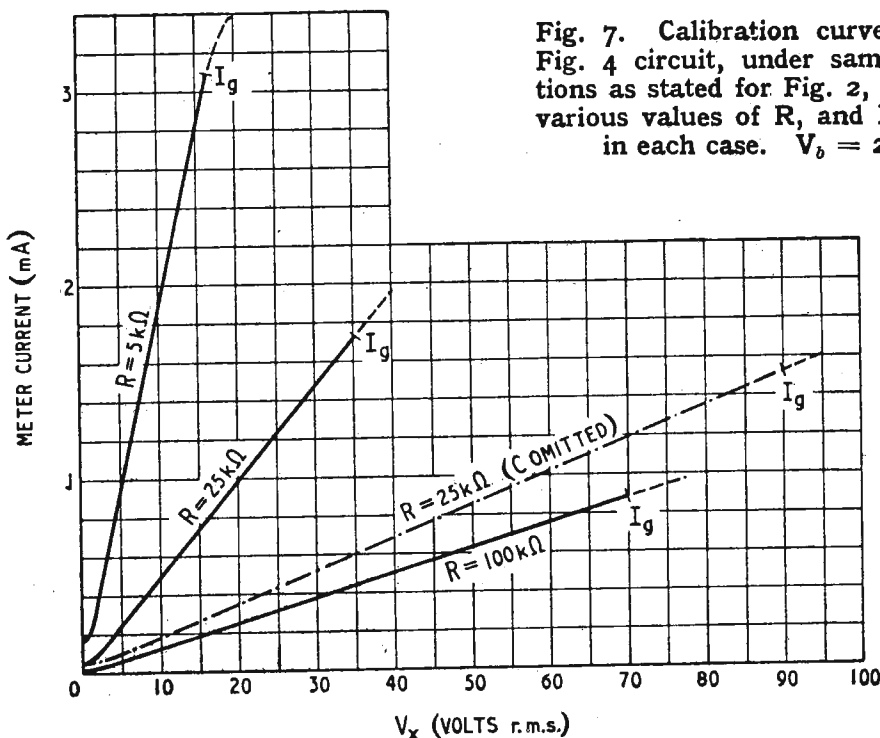

Fig. 7. Calibration curves, using Fig. 4 circuit, under same conditions as stated for Fig. 2, but with various values of R, and  $R' = \mu R$  in each case.  $V_b = 200$ .

One of the things to note is that the peakier the waveform the more the grid-current point restricts the maximum allowable amplitude of  $V_x$ . For as  $V_x$  increases, the portion of each cycle during which current flows diminishes, and the current peak has to be so much greater in order to have a given mean value. This can be seen well on an oscilloscope.

would also be almost entirely independent of the valve characteristics. It is clear from the diagram that to approach this ideal the load line slope should be very gradual compared with that of the valve curve. In other words, R should be very large compared with the mutual resistance,  $1/g_m$ . The ratio of the shaded portion of the voltage wave to the rest is approximately  $k/g_m : R$ , where  $k$  is the ratio of peak to mean current. This  $g_m$  is, of course, the average over the working part of the curve, which includes the bottom bend, so will be less than the figure given in the manufacturer's catalogue.

Making R very large necessitates a low-reading meter, or increases the value of  $V_x$  for a given deflection. The need for the sensitive meter can be overcome by using a second triode as a cathode-follower current amplifier; but with two triodes one might as well use the balanced type of instrument.

In practice, using a milliammeter rather than a microammeter—and especially with peaky waveforms—the response

**Reflex Valve Voltmeter—**

of this type of instrument, although approximately peak, is more or less influenced by the mean value of the positive half-cycle of input.

With unsymmetrical square waves, the half-cycles with the greater duration have the less

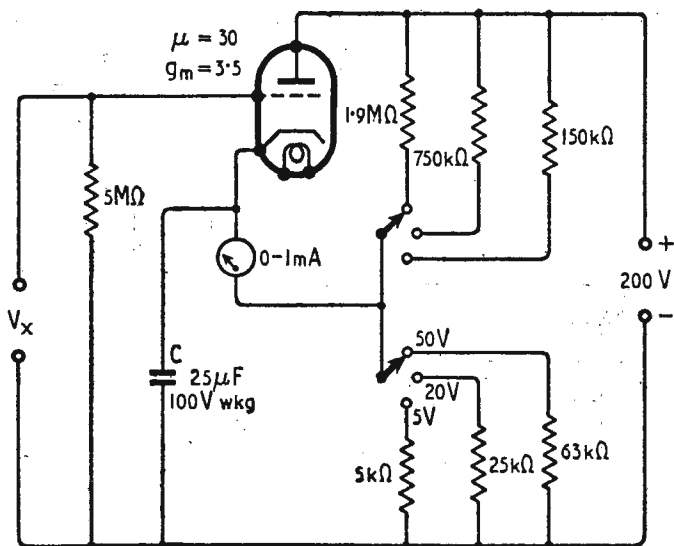

amplitude and therefore give the smaller reading; but this principle is partly offset by the fact that when the duration is less the shaded portions (during which current flows) must have greater area, and therefore doubly greater amplitude in order to yield the greater mean value of current to develop the greater voltage drop across R. This is shown in Fig. 6, where the arrows indicate the relative deflections in each case.

By the simple expedient of omitting C, thus converting the system to a cathode follower, the voltmeter can be made to respond fairly accurately to mean values of positive half-cycles of all except small voltages. The stabilizing resistance, R', remains effective. The sensitivity is reduced to about one third, and since stray capacitance tends to restore the higher sensitivity at high frequencies, it is advisable to restrict this arrangement to audio and perhaps low radio frequencies.

Experimental calibration curves are shown in Fig. 7 for the conditions indicated. In each case the start of grid current is marked. For comparison, one curve with C omitted is also shown; as one would expect, the current for a given V<sub>x</sub> is reduced to approximately 1/π, that being the ratio of mean to peak of half-cycles of sine waves. In all cases the

response is practically linear above about 2 V.

Fig. 8 suggests how to use a 0-1 mA meter and a typical triode to cover ranges of 5, 20, and 50 V. If required only for frequencies not exceeding about 100 kc/s it would probably be convenient to omit C and divide all the resistance values by about 3. A very simple unit would do to supply the 200 V, as only a few milliamps (peak) are needed, and the regulation can be very poor.

We still have not shown theoretically why the beautifully level dotted lines in Fig. 2 were just

Fig. 8. Outline design for voltmeter having ranges of 5, 20 and 50 volts.

what one ought to expect.

What we have to prove is that the mean current through the valve, which we shall denote by I<sub>a</sub>, is not affected by variations in V<sub>b</sub> (provided of course that V<sub>b</sub> does not fall below the level necessary to allow sufficient peak current to flow through the valve to maintain the mean current).

The effect on the valve curve of altering V<sub>a</sub> and/or V<sub>g</sub> is to shift it bodily to left or right, and V<sub>g</sub> shifts it μ times as far as an equal V<sub>a</sub>. The error involved

in this assumption is small, especially as the calibration of the instrument depends only to a minor extent on the precise shape of the curve.

Now V<sub>g</sub> (with any signal, V<sub>x</sub>) is represented in Fig. 5 by OB + BF. OB we already know is V<sub>b</sub>/(μ + 1), and BF is given by the effective load resistance, Rμ/(μ + 1), multiplied by the mean current, I<sub>a</sub>. So

$$V_g = - \frac{V_b}{\mu + 1} - \frac{I_a R \mu}{\mu + 1}$$

Also

$$V_a = V_b - IR$$

$$= V_b + V_g \frac{V_b}{\mu + 1} - \frac{I_a R \mu}{\mu + 1}$$

$$= \frac{\mu V_b}{\mu + 1} - \frac{I_a R \mu}{\mu + 1}$$

Assuming for the moment that I<sub>a</sub> is (as we wish) constant, the only terms in the above expressions for V<sub>g</sub> and V<sub>a</sub> that vary with V<sub>b</sub> are -  $\frac{V_b}{\mu + 1}$  and  $\frac{\mu V_b}{\mu + 1}$  respectively. As the latter is μ times the former and of opposite sign, their effects cancel out, and our assumption that I<sub>a</sub> would be constant is justified.

It should not be difficult to see that varying V<sub>b</sub> can be represented in Fig. 5 by moving the point O horizontally, carrying the voltage scale with it. The effect of increasing V<sub>b</sub> therefore is to allow a greater scope for peak anode current and so to enable a larger V<sub>x</sub> to be applied without running into grid current.



**Books Published for "Wireless World"**

	Net Price	By post
GUIDE TO BROADCASTING STATIONS. Fifth Edition ...	1/6	1/7
RADIO VALVE DATA. Characteristics of 1,600 Receiving Valves ...	3/6	3/9
FOUNDATIONS OF WIRELESS. Fourth revised Edition, by M. G. Scroggie, B.Sc., M.I.E.E. ...	7/6	7/10
RADIO LABORATORY HANDBOOK. Fourth Edition, by M. G. Scroggie, B.Sc., M.I.E.E. ...	12/6	12/11
WIRELESS SERVICING MANUAL, by W. T. Cocking, M.I.E.E., Seventh Edition ...	10/6	10/10
TELEVISION RECEIVER CONSTRUCTION. A Reprint of 10 articles from "Wireless World" ...	2/6	2/9
RADIO DATA CHARTS, by R. T. Beatty, M.A., B.E., D.Sc., Fourth Edition—revised by J. McG. Sowerby, B.A., Grad.I.E.E., ...	7/6	7/11
WIRELESS DIRECTION FINDING. By R. Keen, M.B.E., B.Eng.(Hons.), Fourth Edition ...	45/-	45/9

A complete list of books is available on application

Obtainable from all leading booksellers or from

ILIFFE & SONS LTD., Dorset House, Stamford Street, London, S.E.1.

# Properties and Uses of Negative Temperature Coefficient Resistors

**E**SSENTIALLY the thermistor is a device which possesses a high negative temperature coefficient of resistance, and this unusual property makes it useful in many electrical devices.

Thermistors of many types are in regular production by Standard Telephones and Cables, and their ready availability means that they may be considered for use in modern circuitry. While many materials can be used, that which has been developed as a result of thirteen years' work in the research laboratories is made from a mixture of various metallic oxides, which are heat-treated to extremely high temperatures in an oxidizing atmosphere. By control of the mixture and firing temperature schedule, the resistivity and temperature coefficient can be varied in very wide ranges.

These thermistors, when operated within their rated limits and in neutral or oxidizing atmospheres, are quite stable with time, and no limit to their life is known.

## Forms of Thermistors

To meet the majority of applications, a series of designs has been standardized and put into production. They may be divided into the following types:—

### Bead Types

In these types the thermistor element is a small bead unit mounted on parallel platinum wires. The diameter of the bead is about 0.02 in., and the arrangement is shown in Fig. 1. The bead types are made in two forms, directly-heated and indirectly-heated. In the directly-heated form, the bead as described is welded to stouter lead wires and the unit sealed into a glass bulb for protection. In indirectly-heated types the bead is provided with a thin electrical insulating coating, I, upon which a minute 100-ohm heater, H, is wound (Fig. 2). The whole unit is

## THERMISTORS

attached to suitable supports and leads, and is sealed into a small glass bulb which may be highly evacuated or gas filled, depending upon the applications.

### Block Types

In these types much larger pieces of material are employed. For example, circular discs are made by sintering aggregates formed by pressing thermistor

Fig. 1. Bead-type thermistor with embedded platinum leads.

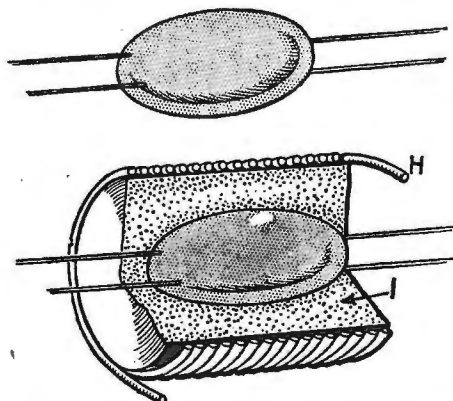

Fig. 2. Indirectly-heated thermistor with insulated auxiliary winding.

powder in moulds under hydraulic pressure; and rods are formed by firing lengths of thermistor "dough" which have been extruded through circular dies. After firing, these types are prepared for use by metallization of contacts followed by the soldering on of tinned copper lead wires.

### Characteristics

The thermistor at constant temperature has an "ohmic" resistance, the current being proportional to the voltage. The resistance  $R$  varies with the absolute temperature  $T$  according to the relation:—

$$R = a e^{b/T}$$

where  $a$  and  $b$  are constants.

The temperature coefficient of resistance is given by:—

$$\alpha = -\frac{b}{T^2}$$

and thus decreases as the temperature rises.

By control of the manufacturing processes, the resistivity of the material can be varied in a ratio of 500 to 1, and in general it can be said that the higher the resistivity the higher the negative value of temperature coefficient. The beads mentioned can, for example, be produced with room temperature resistances of 500 to 500,000 ohms and with temperature coefficients for the latter of the order of  $-4$  per cent per  $^{\circ}\text{C}$ . This may be compared with a value of the order of  $+0.003$  for metals.

There is another rather striking property of thermistors which results from the negative temperature coefficient. Consider a thermistor connected to a source of electrical power; then energy will be dissipated in the thermistor, which will raise its temperature and decrease its resistance. For small power inputs the loss of heat by convection can equal the input, and the thermistor is maintained at a constant temperature slightly above its surroundings. When the temperature difference reaches a value usually around  $30^{\circ}\text{C}$ , a condition arises where this balance is no longer maintained, and the temperature starts to rise. This results in a greater dissipation and further temperature rise, and will ultimately result in destruction of the thermistor unless the power dissipation is limited by external resistance. With such a resistance, the current will rise to a new stable value, which may be many times larger than the initial current. The circuit has behaved rather like a relay. When the thermistor is provided with a separate heating element, the simple characteristics can be greatly modified by variation of the current flowing through the heater.

With any thermistor, therefore,

**Thermistors—**

there is a critical voltage which, if applied across it, will cause the temperature to rise and the resistance to fall until limited by some other part of the circuit. With thermistor elements of the same size, this voltage  $E_{\max}$  increases with the square root of the resistance. It decreases as the ambient temperature increases, and increases if the thermistor is connected to a better "heat sink."

**Uses of Thermistors**

The most obvious application of the thermistor is for resistance thermometry. The very small

tioned earlier, the circuit may be arranged so that, when the thermistor reaches a certain temperature, the current rises abruptly to a much larger value, and this may be used to operate signals.

Other types of thermistors are available for use as bolometers, and perhaps the greatest application to date has been to the measurement of power at centimetric wavelengths. For this purpose, very small beads are mounted between colinear wires which are then supported in appropriate positions, and with proper matching, in waveguides or coaxial line systems. The power dissipated by the radio frequency

compensation, though this can be accurately achieved only over a small range of temperature.

**Surge Suppression**

The properties of thermistors are well suited for the suppression of current surges of short duration, and especially those due to switching. At the moment of arrival of the surge, the thermistor must be cold and of high resistance, and after a time the resistance must be so low that it can remain in the working circuit without causing embarrassment.

The switching of tungsten filaments is a familiar case, accompanied by very large surges. For instance, when a tungsten-filament lamp is switched on to its normal running voltage, a momentary surge of current of 5 to 10 times the normal current is produced. In some cases this is objectionable, because the mechanical effects on the filament

Selection from the range of thermistors made by Standard Telephones and Cables. The letters and figures indicate the type reference numbers. Those in the glass envelopes comprise bead types, both directly and indirectly heated. The long thermometer type F has the thermistor sealed into the top of the glass. The sintered block types are used for thermostatic control.

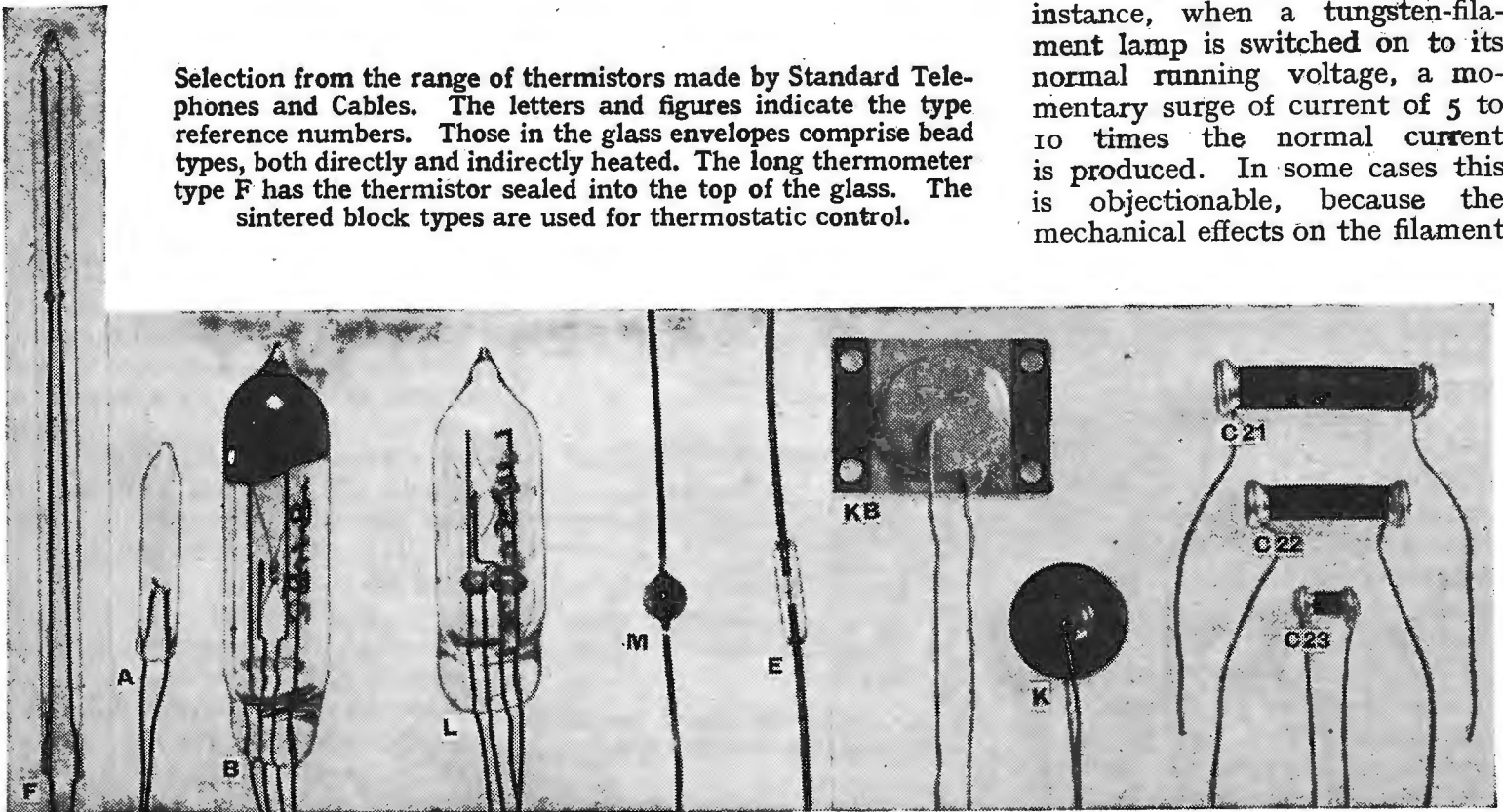

dimensions and thermal capacity of the thermistor bead result in a thermometer with a very small "bulb," and high speed and sensitivity. But because of this, care must be exercised to reduce errors which arise due to the measuring bridge current itself modifying the temperature of the thermistor; and the bridge current must be reduced to a very small value. When this is done, temperatures can be measured with an accuracy of  $0.001^{\circ}\text{C}$  and, provided the instrument is carefully handled, the resistance-temperature curve will remain stable.

Thermistors can also be used as protective devices. By use of the maximum voltage effect men-

is absorbed in the bead, and changes its resistance. The unit may be calibrated with a.c. or d.c., which is adjusted to give the same resistance change. Much ingenuity has been applied in the development of special bridges which maintain constant resistance in the thermistor bolometer by automatically varying the amplitude of a low-frequency current superimposed upon the high-frequency current flowing in it.

Thermistors can also be used to compensate for temperature changes of resistance of copper in measuring instruments. For example, a thermistor in series with the shunt of a voltmeter can be employed to give temperature

may cause distortion; in other cases the surge may render protection of the circuit by fuses very difficult. A familiar case is that of the photoflood lamp where elimination of the switching surge results in an appreciable increase of life.

Another example is provided by the series operation of valve heaters. In this case the switching surge may rise to five or six times the running current. While this may not be very serious when all the valves are alike, it may be disastrous if the heaters are dissimilar. For example, one may be a cathode-ray tube in a television receiver with a heater which comes up to operating tem-

perature much faster than those of the other series valves, or there may be a dial lamp which comes to full brightness in a very short time. In these cases, the heater which reaches running temperature first has to pass an overload current while at normal or higher than normal resistance for some seconds. In one actual case it was found that a cathode-ray tube designed for 6.3 volts was actually subjected to 18 volts for a few seconds during switching. Now, by the use of an appropriate thermistor in series with the heaters, the surge can be either completely suppressed or reduced to safe proportions, so that heater burn-outs of this nature are eliminated.

For this purpose the type CZ Brimistor was designed. It is in the form of a rod with end wires for direct soldering into the circuit. It is made in various sizes to suit the common heater ratings.

Similar problems occur in telephone circuits, where inductive surges from switching or dialling operations may cause annoyance.

The indirectly-heated thermistors lend themselves to many varied uses in electronic apparatus. By variation of the current through the heater, the resistance of the thermistor may be varied in a ratio of 500:1, and the power lost in the heater to cause this change is only of the order of 60 milliwatts. This form of thermistor can therefore be used as a remotely controlled variable resistance. Naturally, the dissipation in the thermistor element must be kept small if the resistance is to obey accurately the orders it receives from the control circuit. With this limitation, the device can be very valuable in amplifier gain-control circuits. The heater is small, and has such low inductance that the control circuit may be operated directly by radio-frequency currents, and useful arrangements for automatic control of level can be devised.

Similarly, the use of thermistors in phase shifting networks opens up many possibilities.

The trigger effect which is obtained when the critical voltage is applied to the thermistor is often made use of to provide a relay. By the application of voltages close to the critical value,

the circuit behaves as a time-delay relay, and reliable timing up to periods of 10 or 15 seconds can be secured. By the use of the indirectly-heated thermistors, the time delay can be varied according to the power dissipated in the heater. It is necessary to point out that in this and some other of the applications, the sensitivity of the thermistor to temperature is such that variation of room temperature will cause variation of performance. This can be overcome by a more complex circuit in which another thermistor is provided to balance out the effects due to this cause.

Enough has been said to indicate the extraordinary versatility of thermistors. In their modern form they are reliable instruments which will continue to function without variation as long as they are correctly used. Though they are semi-conductors, their resistance at constant temperature is truly ohmic, and their use in audio- or radio-frequency circuits results in no measurable distortion. Their high sensitivity can be used to advantage in many measuring and controlling circuits, and it is safe to say that the extent of their field of application is limited only by the ingenuity of circuit designers.

#### ANTI-IMPLOSION

THE Radio Manufacturers Association of America has formulated the following set of precautionary rules to minimize risk in handling cathode-ray tubes when they are being fitted in a set, or a faulty one is being replaced.

1. Don't remove the tube from its carton until you are quite ready to use it.
2. Always wear goggles with safety glass, or its equivalent, when handling the naked tube.
3. Keep other persons, especially children, at a safe distance when the tube is out of its container.
4. Always place the tube on a soft padding whenever it is set down, or better still, return it to its carton.
5. When replacing a defective tube put the old tube into the protective carton and dispose of it as soon as possible.
6. Never leave defective tubes lying around. One safe way of disposing of the tube is to seal it in the carton and then drive a crowbar through the closed top of the container.
7. Dummy tubes should be used when possible for display purposes.

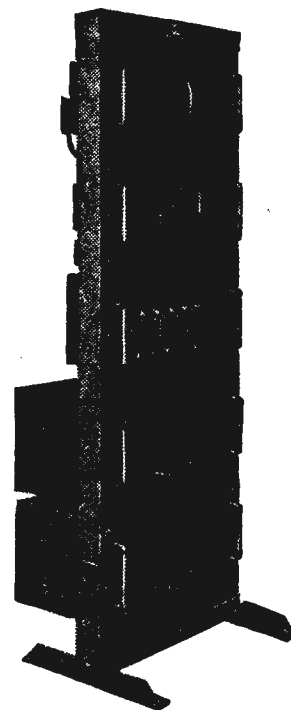

For every SOUND  
AMPLIFICATION  
requirement  
from 5-500 w.  
*it pays to use*

**TRIX**

*Quality*

**SOUND EQUIPMENT**

SEE OUR LATEST EQUIPMENT

**STAND 101**

Grand Hall

**RADIOLYMPIA**

including Amplifiers, Mixers, Gramo-Radio Amplifiers, High Fidelity Reproducers, High Power Rack Equipment, Portable Battery and Mains Models, Microphones, Loudspeakers, Accessories and the new Intervox Two-way Communication System.

**THE TRIX ELECTRICAL CO. LTD.**  
1-5 Maple Place, Tottenham Court Road,  
London, W.1. Phone: MUSEum 5817  
Grams & Cables: "Trixradio, Wesdo, London."

AMPLIFIERS · MICROPHONES · LOUDSPEAKERS

## LETTERS TO THE EDITOR

### Copenhagen Plan: B.B.C. View ♦ Leaning Television Images ♦ C.R. Tube Problems

#### "Intermediate Frequency and the Copenhagen Plan"

THE article by G. H. Russell in your September issue appears to contain serious errors, and as a result it gives an unfairly pessimistic picture of reception conditions when the Copenhagen Plan comes into operation.

Allowing the author's implicit assumption that intermediate frequencies which give rise to a whistle of 9 kc/s or less are unusable, some of his errors seem to be:—

(1) The bands of intermediate frequencies unusable because of second harmonic interference are shown in Table II to be up to 45 kc/s wide, whereas the figure should be 18 kc/s if the interfering carrier is below the oscillator harmonic frequency and 6 kc/s if the interfering carrier is above it.

(2) Intermediate frequency bands rejected because of second-channel interference have widths up to 20 kc/s. These should be 9 kc/s in every case.

After correcting Mr. Russell's tabulation it is found that the following bands are clear:—

497.6 kc/s to 499.0 kc/s  
490.0 kc/s to 491.6 kc/s  
458.5 kc/s to 469.0 kc/s  
434.6 kc/s to 436.0 kc/s  
387.0 kc/s to 388.0 kc/s  
373.0 kc/s to 378.0 kc/s  
309.0 kc/s to 310.3 kc/s

Incidentally it is of interest to note that, applying Mr. Russell's assumptions to the present distribution of B.B.C. frequencies, one of the bands of i.f. that cannot be used (among many others) is from 456.5 kc/s to 465.5 kc/s. But nevertheless he refers to "the popular intermediate frequencies of 456 and 465 kc/s"!

In addition I think it is a very debatable point whether the spurious responses due to i.f. third harmonic, the second-channel frequency at 200 kc/s, and oscillator 2nd harmonic on 200 kc/s, should have been included. Measurements we have made on typical modern superhets with one signal-frequency tuned circuit indicate that these factors are of negligible importance. However, in case where interfering signals are objectionable a simple rejector circuit, like those at present supplied

by receiver manufacturers, would solve the problem.

The difficulty in some parts of the North Region due to the proximity of 668 kc/s with the combination of 200 kc/s and 465 kc/s will be eliminated under the Copenhagen Plan as the northern frequency at 692 kc/s will be sufficiently remote. Moreover, the possibility of interference from International Common Frequencies is unlikely as the transmitter powers will be so low.

A careful examination of the Copenhagen Plan shows that the likelihood of interference due to these several causes is little different from that existing under the Lucerne Plan. The margin of frequency tolerance to safeguard against ageing of i.f. circuits is also as great under the new Plan.

I am sure your readers know that agreement on a wavelength distribution plan is reached only after the most exhaustive examination of the requirements of all the participating countries; the need to have allocations which minimize interference of this kind is only one of many problems which have to be borne in mind. On the whole, I feel there are grounds for hoping that, with the orderly distribution of wavelengths in Europe, broadcasting in the United Kingdom will benefit from the implementation of the Copenhagen Plan.

H. BISHOP,  
Chief Engineer, B.B.C.

[Correction: The author of the article referred to in this letter corrects an error in the 5th line of col. 1, p. 324: 485 should read 455.—ED.]

#### "Televising Moving Images"

MOST readers of *Wireless World* realized, I feel sure, that I was to a considerable extent trailing my coat when I wrote the article on this subject for the August issue. My great wish is to see television make rapid advances on the road towards perfection and the surest way of bringing this about is to discover just what its present imperfections are and how they come about. Any provocative article in *Wireless World* is certain to bring in constructive criticism from its wide circle of well-informed readers,

whose strictures and suggestions have helped in the past to point a way to the solution of many a problem.

It is, though, but fair that a critic should read an article with understanding before girding up his loins to tear it and its author to pieces. I feel, therefore, that, as a change from the setting of traps and the springing of them of which he accuses me, I may be allowed to try my hand at rolling out the Barrell! Both television and the cinema obtain their results by deceiving the eye, a point which I stress and re-stress in my elementary book on television; but most people seem to share my view that television's methods of deception are not so successful as those of the cine. Interline flicker I find particularly annoying and that is one reason why I don't feel at all sure that interlacing provides the final answer to the viewer's prayer.

I am well aware that U.S.A. systems use 60 frames per second because that number is called for by their a.c. mains frequency. It has, however, been suggested by writers on this side of the Atlantic that this unavoidable increase of 20 per cent in the number of frames as compared with ours, is a liability (since it wastes good bandwidth) rather than an asset. I sought to show that in the case of moving objects it might not be altogether a disadvantage. But never have I suggested anywhere that we should adopt an image frequency which was not a multiple of 50 or of 25.

Another reader claims that there can be no "lean" of a moving image, since the mosaic of the television camera is an image-storing device. I would accept that were the screen of the receiver c.r.t. also image-storing. The afterglow of screen varies a little in persistence in different makes of television tubes, but it is, I understand, always a matter of a few milliseconds. The truth is that there are not two but three screens concerned in the transmission and reception of a television image; the mosaic, the fluorescent screen and the retina of the eye. Both the first and last are image-storing. The "lean" may thus occur on the screen, but not be noticed by the eye as a lean—though its presence is likely to make for reduced sharpness of the image.

R. W. HALLOWS.

#### "Cathode-ray Tubes for Television"

IN the first part of my article in the June *Wireless World* I did not make it clear that the solution of the problem of how to change a

c.r. tube design and operating conditions to accommodate an increased number of lines assumes negligible deflection defocusing in the prototype tube.

When the number of scanning lines is increased the size of the spot must be proportionately reduced at all parts of the screen. Thus we simultaneously require (1) the undeflected spot size shall be  $1/\mu$  of that on the original (this condition was satisfied in the June solution) and (2) the increase of spot size on deflection shall also be  $1/\mu$  of that on the prototype. This second condition was not met and the solution given is not valid therefore unless the deflection de-

over size on the prototype and M its magnification. But the spot size on the derived tube (undeflected) is to be multiplied by  $1/\mu$  to meet condition (1). This yields  $\mu^2\lambda = \sqrt{(V_2/V_1)}$ .

The condition of constant brightness yields

$$I_1 V_1^n = I_2 V_2^n$$

We can now proceed exactly as in the article, both for the case of constant beam current and constant cathode loading.

The results are given in the accompanying table which should be compared with the last two columns of the table in the June issue. The conditions in this more general case are much more stringent.

Basic Operation.		No. of lines multiplied by $\mu$ . Tube screen dimensions held constant. Fig.1.	
Secondary Operations.		Triode scaled and moved towards focusing coil.	
Geometrical changes made.	Triode dimensions ... ..	$\times 1/\mu^2$	$\times 1/\mu^{2n/(n+1)}$
	Cathode-grid spacing* ... ..	$\times 1$	$\times \mu^{4(3+2n)/3(n+1)}$
	Triode to focusing coil distance ...	$\times 1/\mu$	$\times 1/\mu$
Electrical changes made	Anode voltage ... ..	$\times 1$	$\times \mu^{4/(n+1)}$
	Cut-off voltage ... ..	$\times 1$	$\times 1/\mu^{8n/3(n+1)}$
	Grid drive ... ..	$\times 1$	$\times 1/\mu^{8n/3(n+1)}$
	Scanning-coil current ... ..	$\times 1$	$\times \mu^{2/(n+1)}$
Effects produced.	Beam current ... ..	$\times 1$	$\times 1/\mu^{4n/(n+1)}$
	Spot diameter at all points ... ..	$\times 1/\mu$	$\times 1/\mu$
	Beam angle $\alpha$ ... ..	$\times 1$	$\times 1$
	Screen surface brightness... ..	$\times 1$	$\times 1$
	Cathode loading ... ..	$\times \mu^4$	$\times 1$

\* This adjustment to be made *additionally* to that effected by the scaling of the whole triode.

focusing of the prototype is negligibly small.

But condition (2) can be closely met by reducing the beam width in the deflecting fields to  $1/\mu$  of its original value. This is most easily done by moving the whole triode towards the focusing coil (Fig. 1, June issue) until the geometrical magnification between cross-over and spot is increased  $\mu$  times.  $a$  is kept constant as before.

The spot size on the derived tube will then be  $\mu S M \lambda \sqrt{(V_1/V_2)}$  using the original notation: S is the cross-

With constant voltage and beam current the cathode loading is multiplied by  $\mu^4$  instead of by  $\mu^2$ . With constant cathode loading the voltage must be multiplied by  $\mu^{4/(n+1)}$  instead of  $\mu^{2/(n+1)}$ . Taking  $n = 1.67$  an increase in the number of lines from 405 to 625 demands an increase in tube voltage from 5 to 9.8 kV if the cathode loading and deflection defocusing are to remain unchanged. The scanning-coil current must be increased 1.38 times.

HILARY MOSS.  
Emmer Green.

# Antiference

announce

the "ANTEX" (Regd)

A new conception in Television Aerials

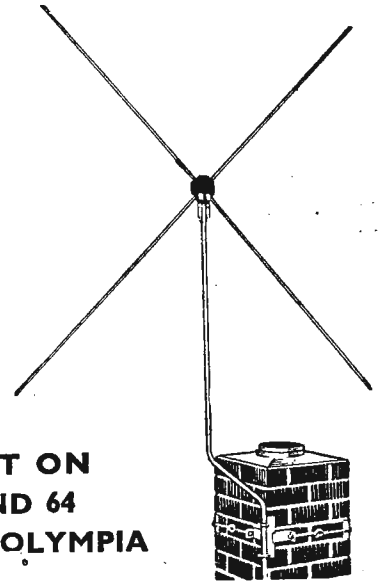

SEE IT ON  
STAND 64  
RADIOLYMPIA

- for greater signal strength
- for greater noise cut
- for less weight
- at less cost

ANTIFERRE Research and engineering knowledge once more lead the way with this revolutionary new "ANTEX" (Regd.) Aerial. With a front to back ratio of 22.0 db. and a forward gain of 2 db. when compared with the standard "H" aerial it brings a new level of quality to television reception. The electrical and mechanical design of this aerial is protected by Patent Nos. 35957/46 and 12178/49 and Reg. Design No. 859630.

**FRONT/BACK RATIO**  
Standard Dipole and Reflector (H array) -7.5 db  
"ANTEX" AERIAL (X array) -22.0 db

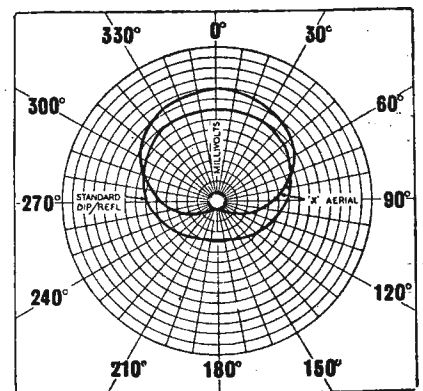

The Forward Gain of the "Antex" Aerial is 2 db better than a standard H array.

MODEL XL for London XL/B for Birmingham including 7 ft. mast and chimney lashing equipment as illustrated ..... £3 10 0  
Model XW for London XW/B for Birmingham including 7 ft. mast and wall mounting bracket ..... £2 17 6

(Deliveries available 6 weeks approx.)

**ANTIFERRE LIMITED**  
67, BRYANSTON ST., LONDON, W.1

# RANDOM RADIATIONS

By "DIALLIST"

## The Capacitor Puzzle

SEVERAL KIND READERS send the suggestion that the queer behaviour by certain old capacitors which I described last month may be due to the fact that with the passage of time they have gradually changed into electrets. If you remember, I told how a 17-year-old paper condenser showed a steady e.m.f. of 0.4 V when a valve voltmeter with an input resistance of  $10M\Omega$  was applied to it. Other old capacitors of the same type showed 0.1-0.2 V. An electret is formed by heating certain dielectric materials to melting point and allowing them to solidify in an electric field. The mass then develops positively and negatively charged surfaces and the charge may be retained almost indefinitely if it is wrapped in metal foil. At first sight this seems to fit in quite well with waxed-paper capacitors. If one of these had become heated whilst charged until the wax was just beginning to run, might not it have turned itself into an electret as it cooled down? There are two objections that I can see to this explanation. The first is that for an electret to be formed it appears to be necessary for the dielectric material to contain polar groups of the  $-OH$ ,  $-COOH$  type and these do not normally occur in the paraffin wax used in paper condensers. It is just possible—perhaps some reader *au fait* with the chemical aspects can give information on that point—that the necessary polar groups may have been formed as time passed by oxidation of the wax. The second objection, which seems even stronger, is this. As I understand it, an electret has a purely static charge; but here we have an e.m.f., which was found to maintain a steady current of  $0.4/10^7 A$ , or  $0.04 \mu A$ . It is difficult to see how that could happen without a continuous electro-chemical reaction to bring it about.

## Speaking of Electrets

The possibilities of the electret for providing biasing voltages in radio gear where no flow of current is involved don't seem to have been very fully explored. I recall reading (and a letter from a reader confirms this) that they were found to have been so used in the radio gear of some Japanese aeroplanes cap-

tured or shot down during the last war. As an electret could provide a source of steady "free" negative bias indefinitely it might be of considerable use to designers of battery-operated wireless receivers. The grid bias voltages needed in these are negative and if they do their jobs properly there should be no flow of grid current. The present practice of obtaining these voltages from the h.t.b. by means of bleeder networks is not ideal, for it means amongst other things that we have to rob Peter in order to pay Paul. In other words, if the voltage available from a new h.t.b. is 120 V, 9 V-12 V must often be used for the grids, leaving a maximum of only 108-111 V for the anode circuits. Harking back to the old paper capacitors which develop appreciable e.m.f.s, one wonders whether their conduct may not be responsible for some mystifying effects in radio receivers and other kinds of electronic apparatus that have been in use for a number of years.

## Trig. Without Trig. Tables

YOU REMEMBER that a month or two ago I wrote of the excellent tip given by an American writer for the rapid evolution in your head of all sine and cosine values? I asked

then if anyone could suggest an equally simple way of memorising a key to tangents. Several readers have pointed out that if you know the sine and cosine, the tangent is

easy, since  $\tan \alpha = \frac{\sin \alpha}{\cos \alpha}$ . That

wasn't quite what I had in mind. What I was after was a second string to one's mental bow: another series of figures, just as easy to memorize as those for cosines, which could be there as a stand-by in case the others were forgotten. One reader sends a suggestion. The series to be memorized for tangents is: 9, 9, 9, 9, 11, 11, 12, 14, 16. Place a decimal point and a nought in front of each; then successive addition to 0 gives you tangent values for every  $5^\circ$  up to  $45^\circ$ . Thus we have

$$\tan 5^\circ = 0.09$$

$$\tan 10^\circ = 0.18$$

$$\tan 15^\circ = 0.27$$

and so on to:

$$\tan 45^\circ = 1.00$$

These figures, like those for cosines, are all correct to 2 decimal places, or to  $\pm 15'$  of angle. To obtain the remaining tangents

simply use  $\tan 50^\circ = \frac{1}{\tan(90^\circ - 50^\circ)}$

and so on. What it all comes to is that whether you memorize one or both simple sets of figures you have a means of arriving at all trig.

## CLOUD DETECTION BY RADAR

PHOTOGRAPHS taken on the recent B.O.A.C. flight to the Far East to test the Ekco cloud and collision warning equipment. The central picture was taken at a range of 20 miles from the cumulo-nimbus formation. The cloud top was approximately 28,000 feet and the air-

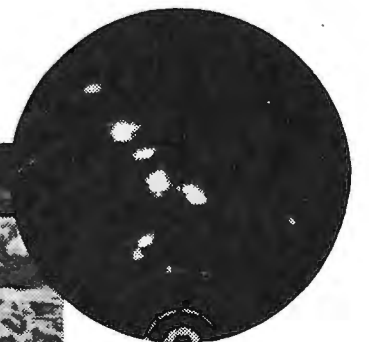
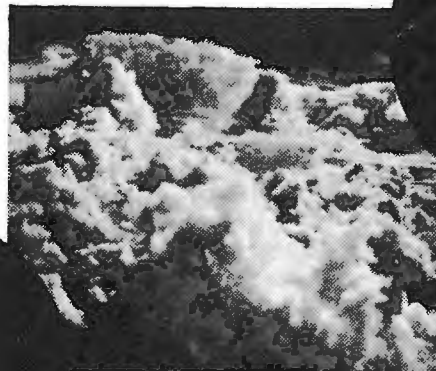
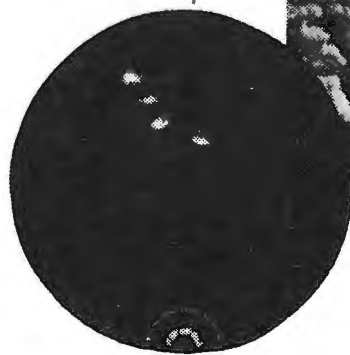

craft was flying at 10,000 feet. The left-hand P.P.I. picture shows responses from the dangerous cumulo-nimbus clouds at 25-40 miles range. In the right-hand picture there are additional responses at 15 miles from cumulus clouds. The cumulus cloud in the foreground did not give a response until the range was down to 10 miles.



ratios—sines, cosines, tangents, cosecants, secants and cotangents—for all angles, with sufficient accuracy for most electrical purposes, almost as quickly as you can look them up in a book of tables. Rather more quickly in my case, for, though I possess a variety of sets of trig. tables, I can seldom put my finger on any one of them when I want it!

### Fluorescent Lamps in the Workshop

WHEN I WROTE RECENTLY of possible risks from stroboscopic effects if fluorescent lighting is used in the amateur's workshop, I had, of course, in mind the kind of fixture that one most commonly sees in homes of ordinary folks—the single 40-watt or 80-watt tube, with or without reflector. Fixtures containing two tubes connected in parallel are easier to come by now than they were and they are obtainable with a built-in phase-splitter which enables freedom from stroboscopic effects to be obtained on the normal single-phase domestic supply. A kind reader sends me a useful tip, with the aid of which anyone worthy of the name of handyman can "destrobify" a dual 40-watt fixture not already fitted with a phase-splitter. The power-factor condenser is removed. Calling the two tubes A and B, A's choke is connected direct to the phase lead of the mains and a  $3.75\mu\text{F}$  capacitor is wired between the phase lead and the choke of B. In this way the e.m.f. applied to A leads the current by about  $60^\circ$ , whilst B's e.m.f. lags  $60^\circ$  on the current. The leading and lagging power factors counter-balance one another. The two tubes are now approximately  $120^\circ$  de-phased and there is no strobing.

### Chinks in the Armour

What fluorescent lighting most needs, I feel, is the development of fluorescent coating materials of longer afterglow. This would automatically put an end to strobing and to the rather annoying flicker effect which is so noticeable when an object with a reflecting surface is moved rapidly in the illuminated area beneath a fluorescent lamp. Whilst on the subject of these lamps I feel I must tell you the true story of certain happenings in Hong Kong after VJ Day. It was related to me by a friend who was chief engineer of the South China Electricity Company before the war and returned to that post after some grim years as a prisoner in Japanese hands. As soon as the war was over the reconstruction of factories and offices went ahead rapidly. The

business community was fluorescent lamp-minded, and this form of lighting was installed here, there and everywhere as quickly as Chinese contractors could carry out the work. Fixtures and tubes were readily available; but there was a serious shortage of p.f. capacitors. That, however, did not daunt the Chinese. A new installation having been made, the company was asked to inspect and approve it. That having been done, the power factor capacitors were removed and used for the next installation. Presently, the company began to find that it was supplying vastly more kilowatts than the consumers' meters were ticking up and immediate strong action had to be taken. A good thing for electricity authorities the world over that the radio valve placing a chiefly reactive load on power supplies has not yet been invented!

### The "Interference Act"

THE WIRELESS TELEGRAPHY ACT of 1949 seems destined to be known popularly as the "interference act" since one of its provisions of high importance to owners of broadcast receivers and television sets is aimed at the suppression of interference of the man-made variety with their enjoyment. The original Bill was altered a good deal as it went its way through Parliament. The Act as it stands is not perhaps so strong as some would like; some, again, may think the procedure laid down by it over-leisurely. When it is proved that apparatus is causing interference the P.M.G. must serve its owner with 28 days' notice to abate the nuisance. That seems rather a long time; but the delay may not end there, for the owner, having received such notice, may then refer the matter to the Appeal Tribunal. The notice then becomes inoperative until the Tribunal has heard the appeal and unless its decision is in favour of the P.M.G. The only exception is when the P.M.G. is satisfied that the interference is upsetting "safety" services such as police radio-telephony or airport radar; he can then demand immediate action.

Whatever its shortcomings, the new Act is a long step in the right direction. It should bring about a big improvement in reception conditions. Some manufacturers have been fitting suppressors to their domestic electrical products since soon after the provisions of the Bill were first made public. Others are bound to follow suit now, for the P.M.G. has power to prohibit the sale or hiring out of apparatus proved to cause serious interference.



### THE "FLUXITE QUINS" AT WORK

"Are you certain that aerial's tight?  
And the flux you used was FLUXITE?"  
Said OI "Why I'm sure:  
And furthermore,  
I'll tug it. You'll see if I'm right."

See that FLUXITE is always by you — in the house — garage — workshop — wherever speedy soldering is needed. Used for over 40 years in Government works and by leading engineers and manufacturers. Of all Iron-mongers—in tins, 10d., 1/6 & 3/-.

TO CYCLISTS! Your wheels will NOT keep round and true unless the spokes are tied with fine wire at the crossings AND SOLDERED. This makes a much stronger wheel. It's simple—with FLUXITE—but IMPORTANT.

The FLUXITE GUN puts FLUXITE where you want it by a simple pressure. Price 2/6, or filled, 3/6

ALL MECHANICS WILL HAVE

# FLUXITE

IT SIMPLIFIES ALL SOLDERING

Write for Book on the ART OF "SOFT" SOLDERING and for Leaflets on CASE-HARDENING STEEL and TEMPERING TOOLS with FLUXITE. Price 1d. each.

FLUXITE LTD.

(Dept. W.W.), Bermondsey Street, S.E.1

# RECENT INVENTIONS

## A Selection of the More Interesting Radio Developments

### Direction and Distance Finder

STANDARD methods of airport control rely on triangulation methods using normal d.f. equipment or on radar methods relying on reflections from an aircraft. The former require two stations while the latter methods may lead to difficulties over the identification of different aircraft, as response is automatic and not dependent on any action taken by the aircraft.

The system here described is applicable to a fixed station and a mobile station and provides for the fixed station emitting a sine modulated carrier which is received by the mobile station and used to modulate an emitted carrier wave of a different frequency. By comparing the phase of the received modulation with the transmitted modulation an indication of the distance of the mobile station can be obtained, while known d.f. methods may be used to obtain the bearing. The transmitter at the mobile station may be the normal communication equipment, and it may emit the modulated carrier at the request of airport control to assist identification.

The specification describes in outline a method of displaying the information on a cathode ray tube at the control point in the form of a radial trace, the rotary position of which indicates the bearing while the position of a "spot" on the trace indicates the distance.

*Standard Telephones & Cables, Ltd., C. W. Earp and R. F. Cleaver. Application date June 21st, 1946. No. 621,575.*

### Pulse Communication

WHEN using pulse communication methods for transmitting several channels over one carrier it has been usual to interleave in time the signal pulses of the several channels. This normally involves synchronizing the pulses in the different channels which cannot always be easily arranged.

The system described utilizes several trains of pulses, each train having a different characteristic pulse width and recurrence frequency, and all the pulses are transmitted over a common communication medium, but without synchronization. Modulation may be by controlling the time positions of the pulses of each train. Unscrambling at the receiver is based on pulse width discrimination.

One method described in outline is based on providing a delay network for each channel giving a delay equal to the pulse width of the particular channel. The composite received modulation is differentiated and inverted, and fed to the delay networks. Combination of the original differentiated wave form with the inverted and delayed wave form will give a double height pulse in the correct channel circuit

where the delayed and inverted peak of the leading edge of the received wave form coincides with the trailing edge of the differentiated wave form without inversion or delay. The several channels are thus selected at the receiver and may be converted into speech or other signals by normal methods.

*Standard Telephones & Cables, Ltd. (assignees of E. Labin and D. D. Grieg). Convention date (U.S.A.) February 26th, 1945. No. 623,415.*

### A.F.C. Systems

IN broadcast receivers a discriminator circuit may be used to control the frequency of a local oscillator by means of a "reactance valve." This system

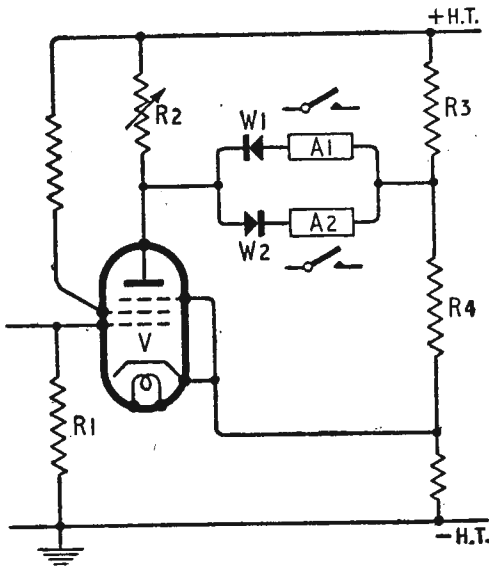

Single-valve motor control circuit for automatic frequency correction.

is not suitable for communication receivers or other apparatus where the received signal may disappear for a length of time, for then the station will be tuned out by the a.f.c. system and may not be again picked up when the signal returns. In these circumstances a motor-operated device is often used, but the known systems require two valves for the two directions of the motor.

In the system shown on the diagram R1 is the load resistance of the discriminator rectifier, which is connected to a pentode V biased to a straight part of the characteristic, and which has an anode load R2. A divider network R3R4 is connected across the h.t. supply as shown. The valve impedance and R2, R3, R4 form a bridge system across which are connected forward and reverse relays A1 A2 fed by oppositely connected rectifiers W1W2. So long as the discriminator is not supplying a control voltage there is no input to V and the bridge is balanced under these conditions so that no current flows in A1 or A2. A control voltage from the

discriminator will raise or lower the potential at the anode of V and current will flow either in A1 or A2 by the action of rectifiers W1 and W2, thus energizing one relay to correct the tuning of the receiver, whereupon the control voltage drops and the relay A1 or A2 releases to stop the tuning motor.

*Marconi's Wireless Telegraph Co., Ltd., and G. L. Grisdale. Application date July 2nd, 1946. No. 622,479.*

### Colour Television

PROPOSALS for colour television have been based on the use of a three-colour filter wheel rotated in front of the cathode ray tube. Such a filter wheel must be synchronized with the transmission. This may depend on the use of synchronized mains power, which is not always available, or of the transmission of pulses which are amplified sufficiently to drive a synchronous motor, which is wasteful and expensive.

These difficulties are avoided by driving the filter wheel by a motor running naturally at a speed slightly higher than the required speed and subjected to the action of an electromagnetic brake. The wheel drives a simple alternator the phase of which is compared with received synchronizing signals in a valve circuit to derive a current which varies with the phase difference and is applied to the brake to reduce the speed until it moves in step with the synchronizing signals.

*Marconi's Wireless Telegraph Co., Ltd. (assignees of F. J. Somers). Convention date (U.S.A.) October 19th, 1944. No. 622,202.*

### Television

THE transmission of a sound channel with the vision signal by modulated pulses in the interline blanking period is dealt with in this specification.

In the system described, which is not limited to transmitting sound but may be used for transmitting other intelligence, modulation pulses are positioned within synchronizing pulses and are spaced from both the leading and trailing edges of the synchronizing pulses. Modulation may be dependent on pulse height, phase, frequency, or, preferably, width. Any edge of the modulation pulses which is variable with modulation always occurs with a minimum time separation from the synchronizing edge of the synchronizing pulse, which exceeds the time period of the pulse of the so synchronized time base oscillator. Thereby time synchronization is unaffected and penetration of the sound pulse into the picture is avoided. Reference is made to the transmission of several sound channels by several successive pulses during each blanking period.

*D. I. Lawson, A. V. Lord and Pye, Ltd. Application date October 12th, 1945. No. 621,479.*

The British Abstracts published here are prepared with the permission of the Controller of H.M. Stationery Office, from specifications obtainable at the Patent Office, 25, Southampton Buildings, London, W.C.2 price 2/- each.



**RADIOLYMPIA**—*We shall be on Stand 75*

Maybe we'll talk condensers—maybe not. Perhaps we'll adjourn somewhere. Whatever it is, it will be grand to see

our hundreds of friends in trade and industry at the best of all shows. Remember the figures — seven five.

**THE TELEGRAPH CONDENSER CO. LTD.**

**RADIO DIVISION**

**NORTH ACTON · LONDON · W. 3**

**Telephone. ACORN 0061**



## The Finest Cored Solders in the World at **RADIOLYMPIA 1949**

### STAND 84 GRAND HALL

#### ERSIN MULTICORE SOLDER

Contains 3 cores of non-corrosive Ersin flux to guarantee flux continuity and sound permanent joints. Approved A.I.D. & G.P.O.

Available for manufacturers as standard in 5 alloys, 9 gauges and 2 flux percentages. 3 types of non-corrosive flux. Wire pre-forms. Multicores rings and washers. Other alloys and gauges to special order.

On this Stand watch staff from E.M.I. Factories manufacturing R.F. units for "H.M.V." Television receivers. Each unit is assembled from 47 parts involving 117 Ersin Multicore soldered joints. See how Ersin Multicore Solder is exported to more than 40 overseas countries. Ask for a free copy of the Ersin Multicore Data Card containing many useful tables for the Radio Technician including Resistor colour code, Ohm's Law, Resistance and Capacitance calculations, etc.



Size 2 cartons 6d. each contain 3 feet 40/60 16 S.W.G. Ersin Multicore Solder—sufficient for 200 average wire-tag joints.



Manufacturers 7 and 1 lb. reels.  
Bulk prices upon request.

Size 1 carton

### SIZE 1 CARTONS 5/- EACH HIGH TIN TELEVISION AND RADIO QUALITY

CAT. REF. NO.	LENGTH	ALLOY TIN/LEAD	S.W.G.
C 16014	26 feet	60/40	14
C 16018	60 feet	60/40	18

### ELECTRICAL AND RADIO QUALITY

CAT. REF. NO.	LENGTH	ALLOY TIN/LEAD	S.W.G.
C 14013	22 feet	40/60	13
C 14016	42 feet	40/60	16



MEET US AT  
**RADIOLYMPIA**  
SEPT 28 - OCT 8

### STAND 83 GRAND HALL

#### ARAX MULTICORE SOLDER

The new cored solder for "difficult metals". Flux residue removed with water. Replaces stick solder, fluid and paste fluxes.

"Diallist" of "Wireless World" who saw an advance sample of Arax Multicore Solder at the R.C.M.F. Exhibition reported in May 1949 issue:

"The solder ran like butter on blued 1/2" clockspring . . . it will be a heaven sent boon to factories and amateur workshops alike."

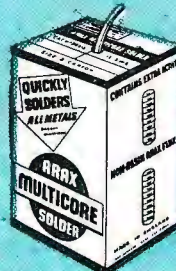

Supplies for manufacturers in 60/40, 40/60 and 20/80 alloys, 3-22 S.W.G. in coils, 1 lb. and 7 lb. reels.

Now available in 5/- retail cartons.

#### MODEL MAKERS QUALITY

AC86013 18 ft. of 60/40 Tin/Lead 13 S.W.G.  
AC86018 60 ft. of 60/40 Tin/Lead 18 S.W.G.

#### METAL MENDING QUALITY

AC84012 18 ft. of 40/60 Tin/Lead 12 S.W.G.  
AC84016 42 ft. of 40/60 Tin/Lead 16 S.W.G.

#### MULTICORE SOLDER KITS

Each contains 4 cartons of Ersin and Arax Multicore Solders.

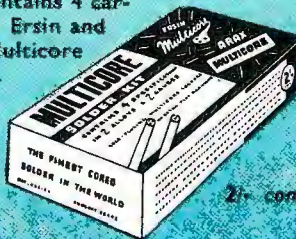

# MULTICORE

SOLDERS LIMITED  
Mellier House, Albemarle St.,  
London, W.1 • REGent 1411



Made from solid-drawn high-conductivity copper, BICC earthing rods are specially designed for use with radio and television receivers. Further information, including sizes and construction, is contained in this Publication (No. 243 T). Send for a copy to-day.

**BRITISH INSULATED CALLENDER'S CABLES LIMITED**  
**NORFOLK HOUSE, NORFOLK STREET, LONDON, W.C.2**



**RADIOLYMPIA**—*We shall be on Stand 75*

Maybe we'll talk condensers—maybe not. Perhaps we'll adjourn somewhere. Whatever it is, it will be grand to see

our hundreds of friends in trade and industry at the best of all shows. Remember the figures — seven five.

**THE TELEGRAPH CONDENSER CO., LTD.**

**RADIO DIVISION**

**NORTH ACTON · LONDON · W. 3**

**Telephone. ACORN 0061**